

MEGA
CONSTRUX™

nickelodeon

TEENAGE MUTANT NINJA
TURTLES



5+

DXY74

2x
MA74397AWA

1x
MA17003BYE

2x
AM18560E

5x
MA1113ATH

2x
MA03328MM

5x
MA1140MM

4x
MA09198APG

2x
MA73758MM

11x
MA09393MM

6x
MA18232APG

10x
MA09013AWA

2x
MA07658AWA

2x
AM78107AWA

2x
MA17153AWA

8x
MA03773AGQ

2x
MA18671MY

1x
AM15064APG

2x
MA1314MM

3x
MA72600APG

1x
AS-DXY74-06

1x
AM73026Z

6x
MA09493MM

3x
MA09033AWA

1x
AM03058ANY

3x
MA1480MY

1x
AS-DXY74-01

2x
AM18259APG

3x
MA09922MY

3x
MA18292MM

1x
AM73222AJM

1x
AS-DXY74-03

1x
AM76951MM

1x
AS-DXY74-04

2x
MA06618AWC

1x
AS-DXY74-02

1x
AM04733BLG

1x
AS-DXY74-05

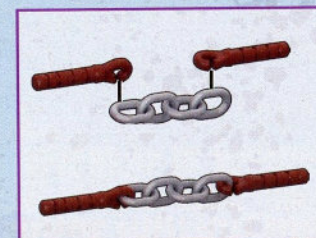

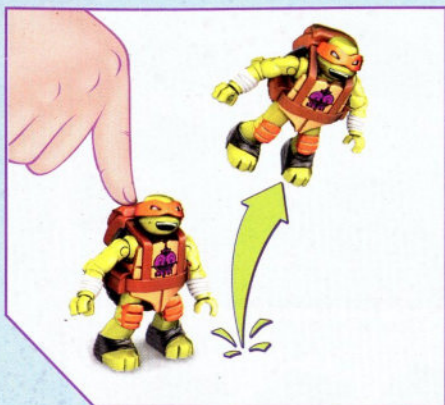

1x
FIG-DXY74-A

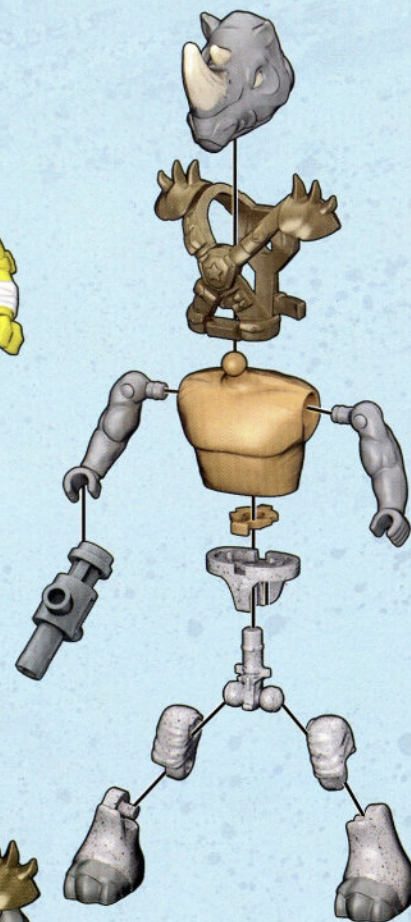
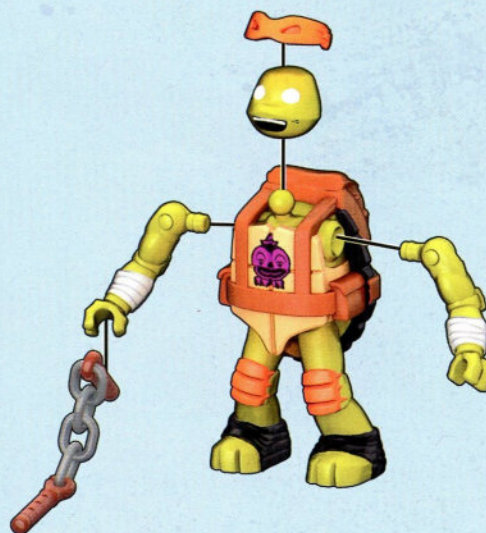

1x
FIG-DXY74-B



- ⚠ WARNING:
CHOKING HAZARD. - Small parts.
Not for children under 3 years.
- ⚠ ATTENTION:
DANGER D'ÉTOUFFEMENT. - Présence de petits éléments.
Ne convient pas aux enfants de moins de 3 ans.
- ⚠ 警告:
噎住危險。包含有小部件
不适合3岁以下的小孩玩。
- ⚠ 警告:
のどにつまる危険 小さな部品が含まれています
3歳以下の子供には与えないで下さい。
تحذير : ⚠
خطر الاختناق - قطع صغيرة.
غير صالحة للأطفال أقل من 3 سنوات.

ADVERTENCIA: Peligro de asfixia. Juguete no recomendado para menores de 3 años, porque contiene piezas pequeñas que podrían provocar asfixia en el caso de ser ingeridas o inhaladas por el/la niño/a.
ATENÇÃO: Não recomendável para crianças com menos de 36 meses. Contém peças pequenas capazes de criar risco de asfixia.
AVVERTENZA: Contiene pezzi di piccole dimensioni.
ACHTUNG: Kleine Teile.
OSTRZEŻENIE: Małe części
WAARSCHUWING: Kleine onderdelen
ПРЕДУПРЕЖДЕНИЕ: Мелкие детали
ADVASEL: Små dele.
VARNING: Smådelar
ADVASEL: Små deler.
VAROITUS: Pieniä osia
ΠΡΟΣΟΧΗ: Περιλαμβάνονται μικρά κομμάτια.
UYARI: BOĞULMA TEHLİKESİ - Küçük Parçalar İçerir. 3 yaşından küçük çocuklar için uygun değildir.



Please read these instructions carefully before first use and keep them for future reference.
Il est recommandé de lire attentivement ce feuillet avant la première utilisation et de le conserver pour référence future.
Leer estas instrucciones cuidadosamente antes de la primera utilización y guardarlas para referencia futura.
Leia as instruções antes do primeiro uso e guarde-as para futura referência.
Leggere le istruzioni prima di cominciare ad usare il gioco e conservarle per referenze future.
Die Gebrauchsanleitung bitte durchlesen und aufbewahren.
Proszę uważnie przeczytać instrukcję obsługi przed pierwszym użyciem, a następnie zachować ją na przyszłość.
Wij raden u aan deze handleiding zorgvuldig te lezen en te bewaren voor eventuele raadpleging op een later tijdstip.
Внимательно прочитайте инструкцию перед первым использованием и сохраните ее для дальнейшего использования.
Vær venlig at læse disse instruktioner omhyggeligt inden ibrugtaget og opbevar dem til fremtidigt brug.
Läs noggrant igenom dessa instruktioner innan du använder produkten för första gången och spara dem för ev. framtida frågor.
Läs disse instruksjonene nøye før første gangs bruk, og ta vare på dem for fremtidige oppslag.
Lue nämä ohjeet huolellisesti ennen ensimmäistä käyttöä ja säilytä ne myöhempää tarvetta varten.
Διαβάστε προσεκτικά τις οδηγίες πριν από τη χρήση και κρατήστε τις για μελλοντική αναφορά.
İlk kullanımdan önce talimatları dikkatlice okumanızı ve bu bilgileri ileride tekrar bakabilmek için saklamanızı öneririz.
第一次使用前，請仔細閱讀本說明書并保留以備將來參考。
初めてご使用になる前に、この説明書をよくお読みください。また、本書は将来いつでも参照できるように保管してください。
يجب قراءة هذه التعليمات بعناية قبل الاستخدام والاحتفاظ بها للعودة إليها مستقبلاً.

© 2016 Viacom Overseas Holdings C.V. All Rights Reserved. Teenage Mutant Ninja Turtles and all related titles, logos and characters are trademarks of Viacom Overseas Holdings C.V. PLAY.MEGACONSTRUX.COM P D714.887

1

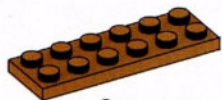

2x

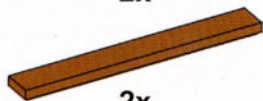

2x

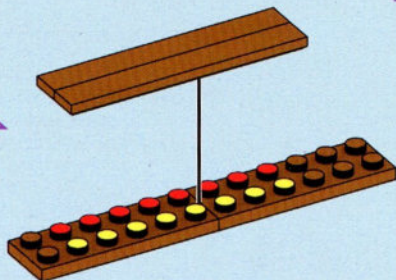

2



2x

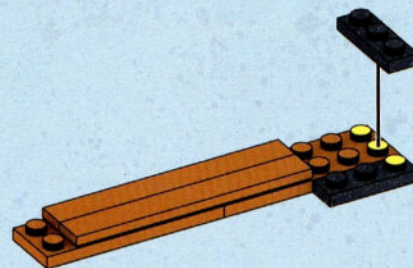

3



1x



1x



1x



1x



1



2

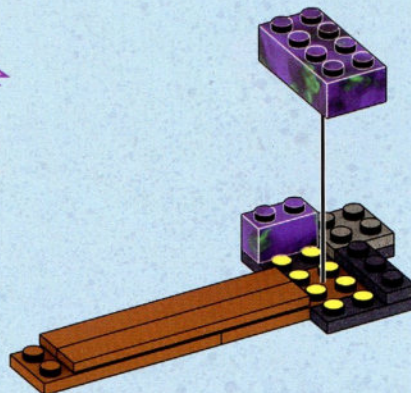

4



1x



1x



1x

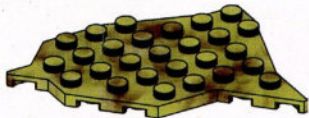

1x



1



2

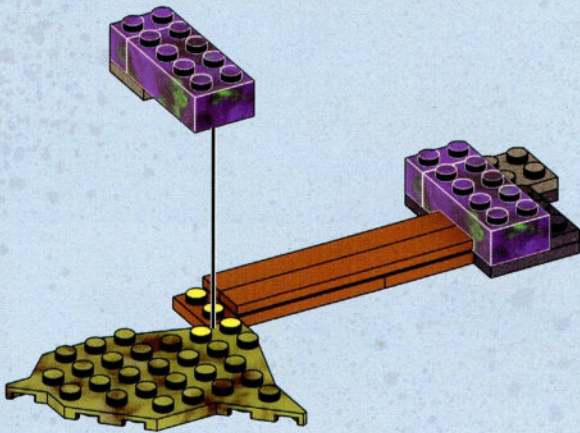

5

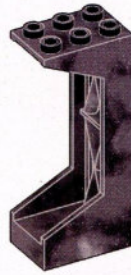

2x

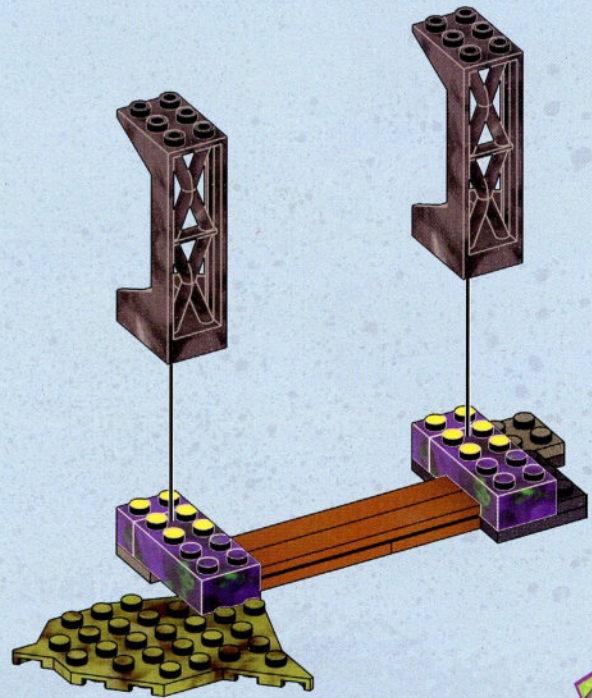

6



2x



6x



2x



2x

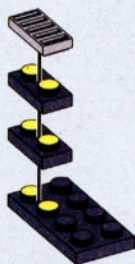

1



2



3

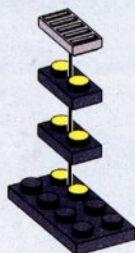

1

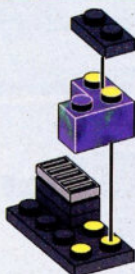

2



3

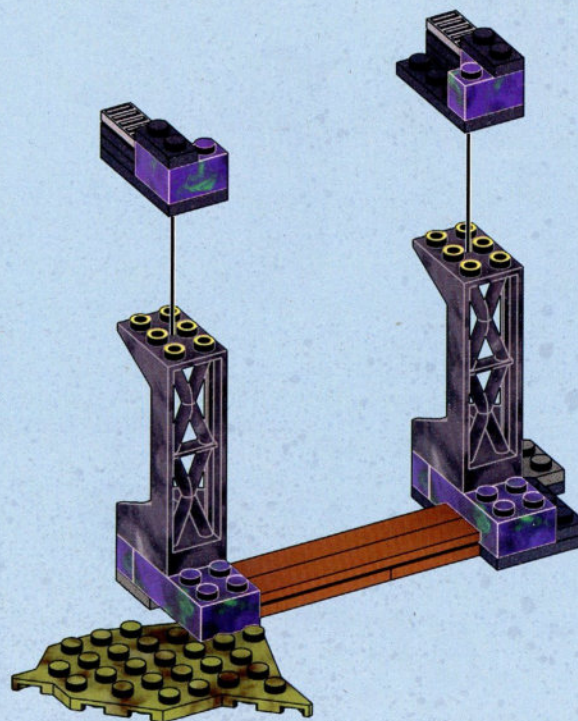

7

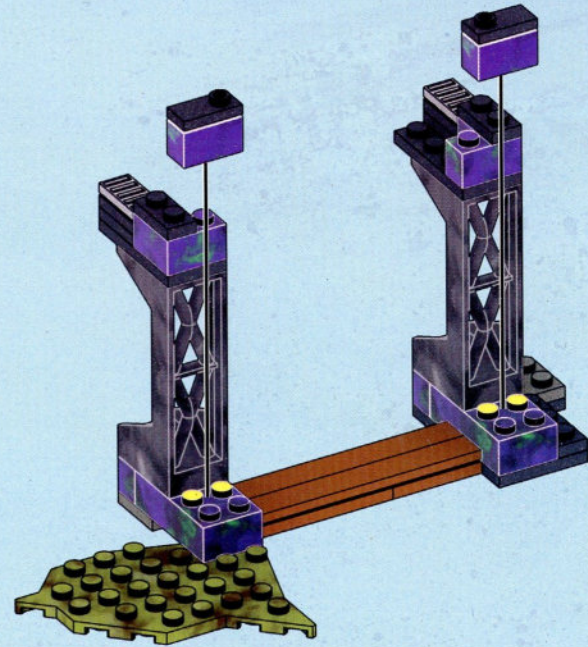
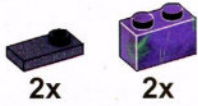

8

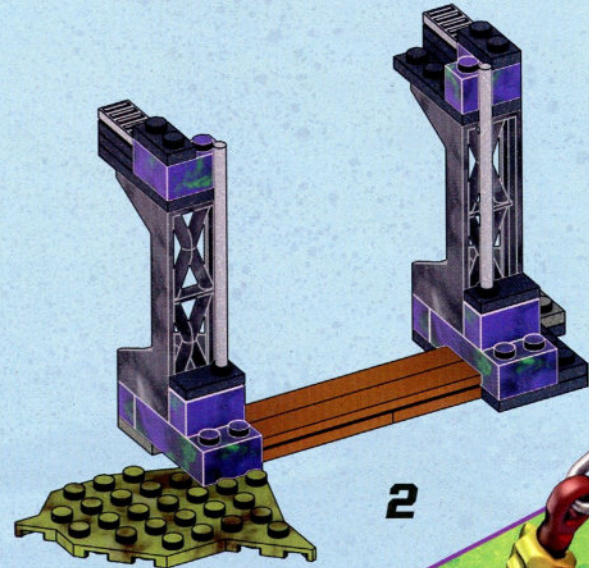
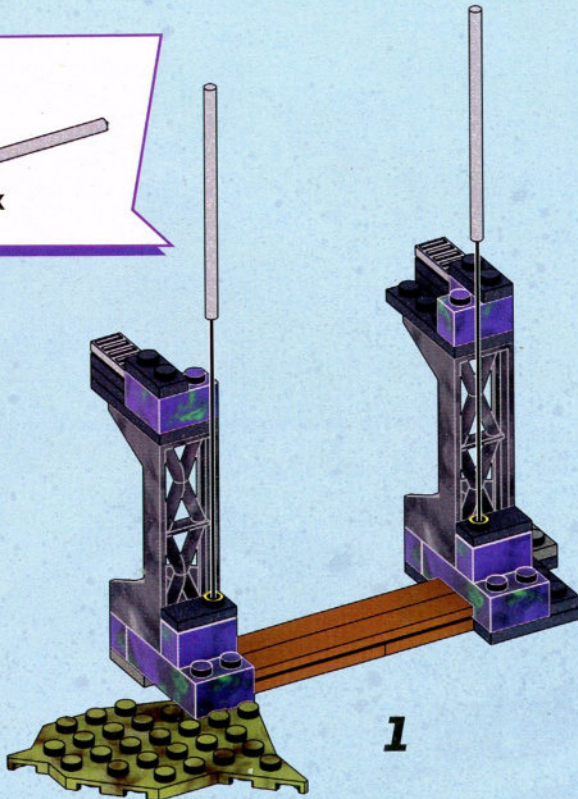
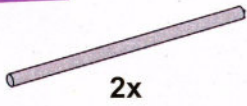

9



6x

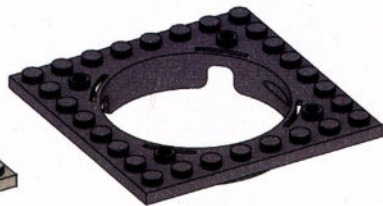

1x

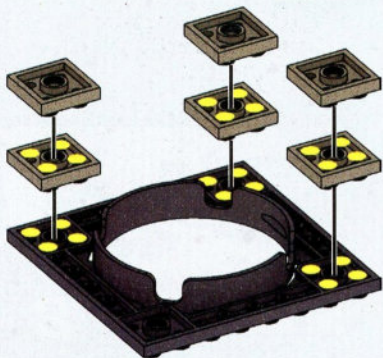

1

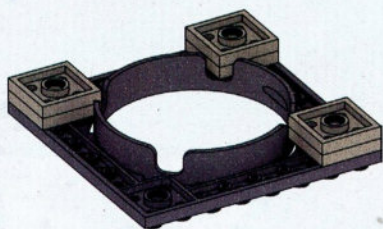

2

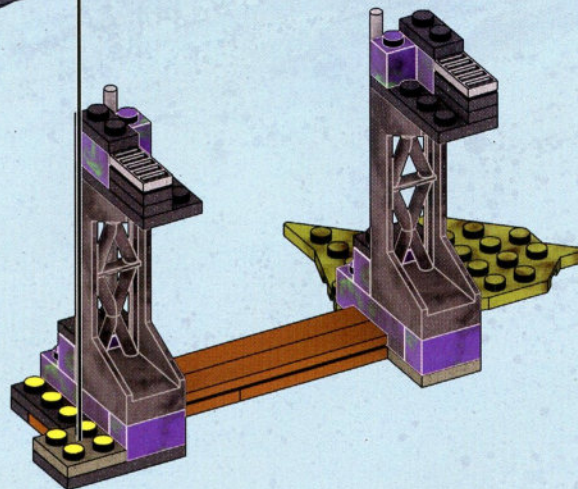
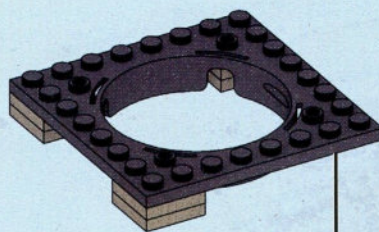

1

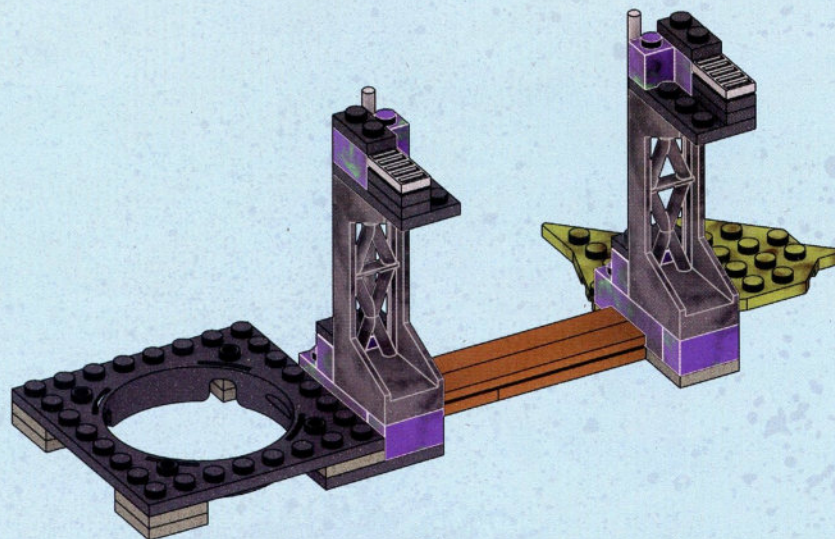

2

10

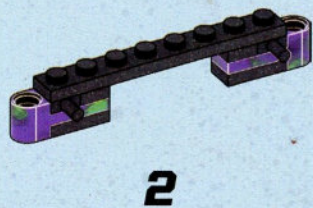
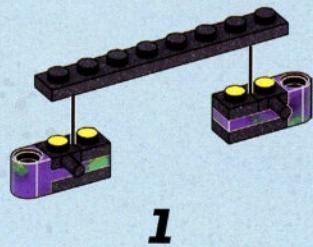
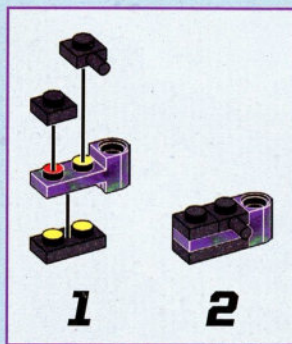
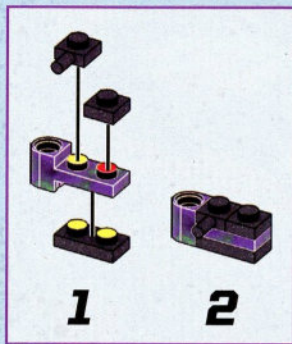
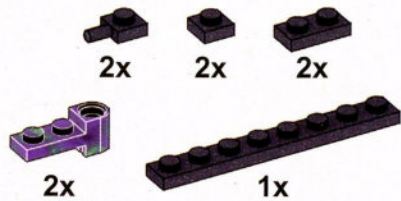

11

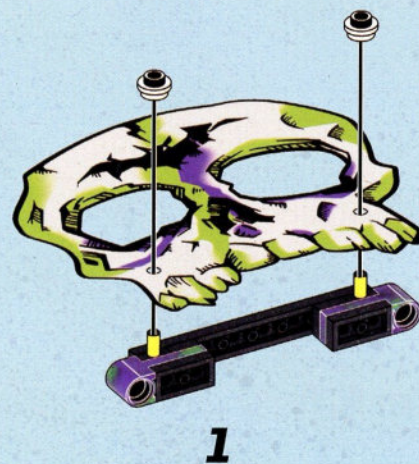

12

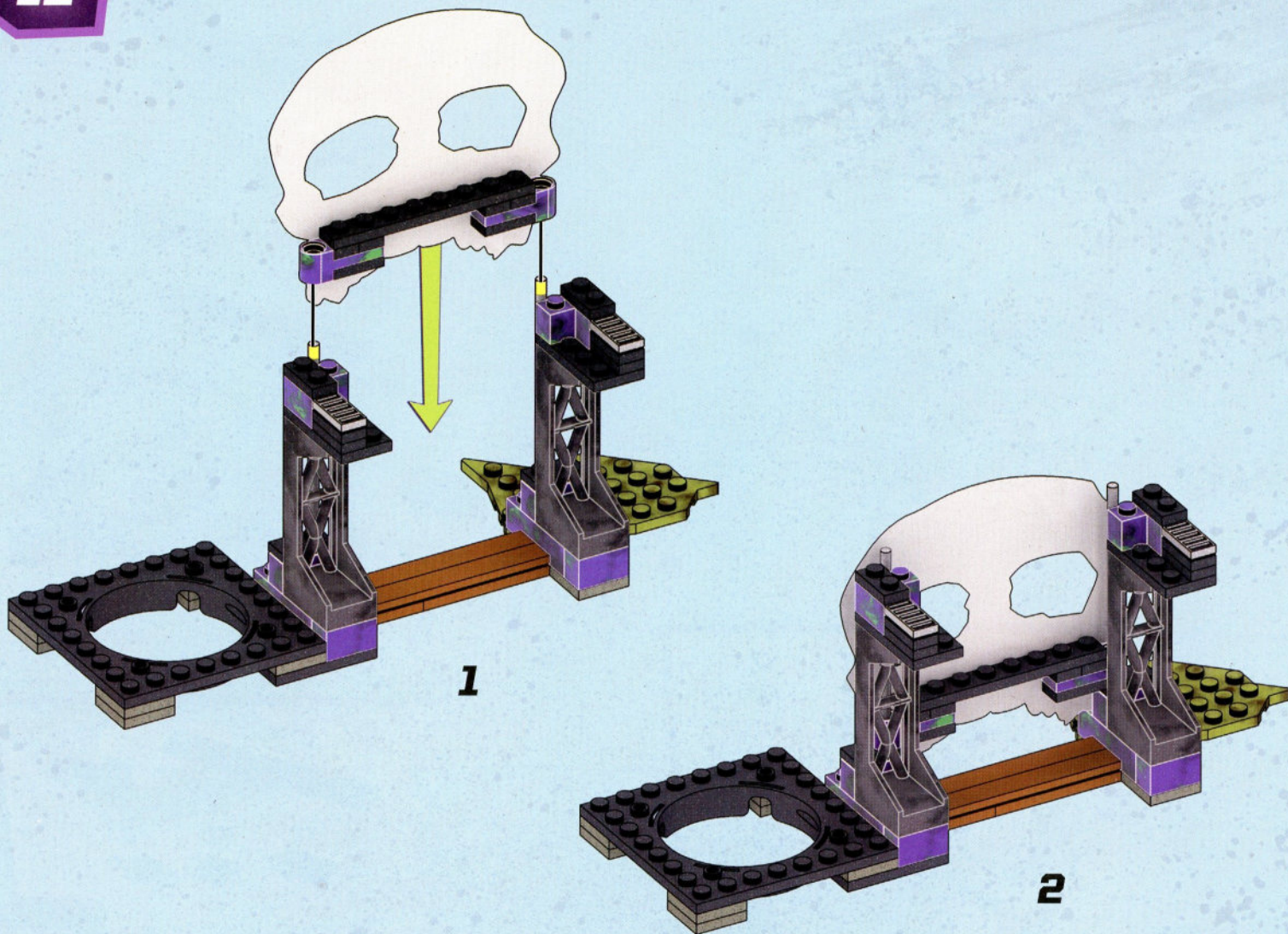

13

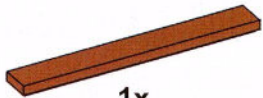

1x

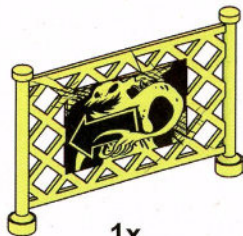

1x

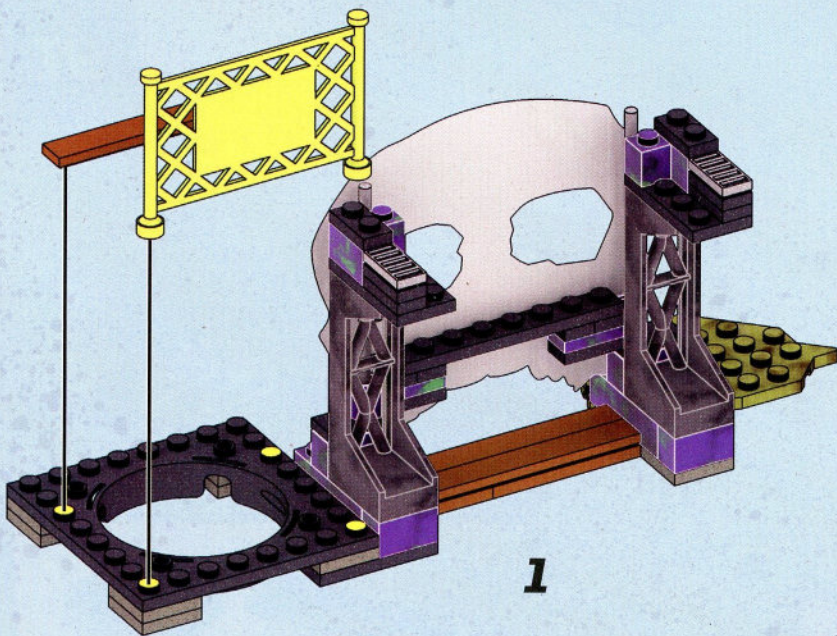

1

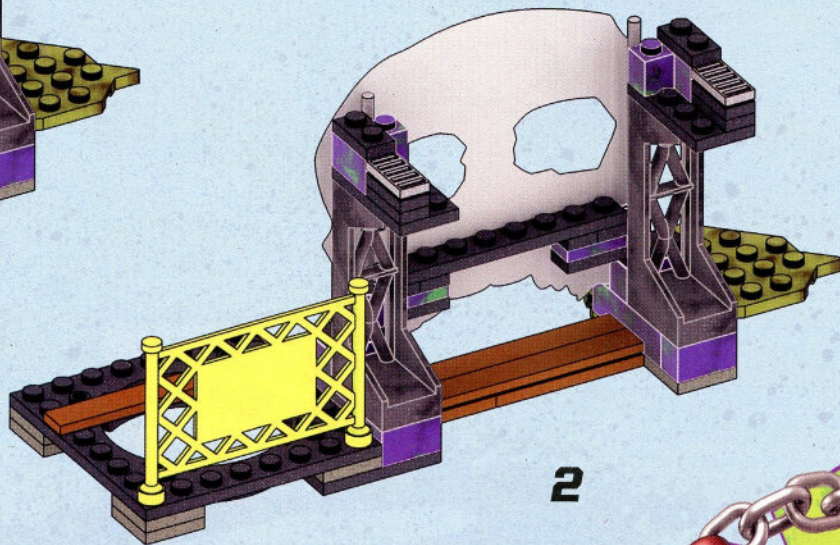

2



14

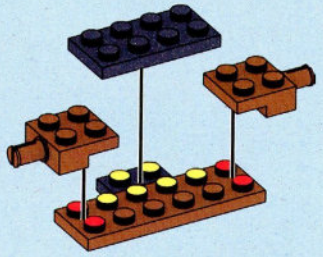
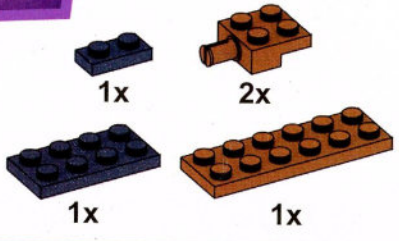

15

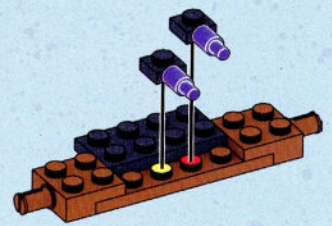
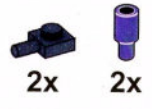

16

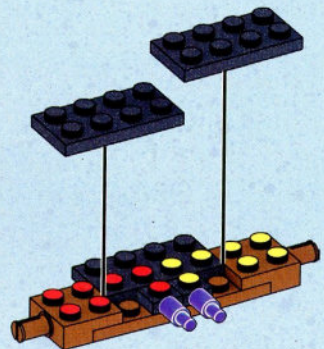
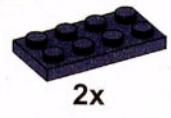

17

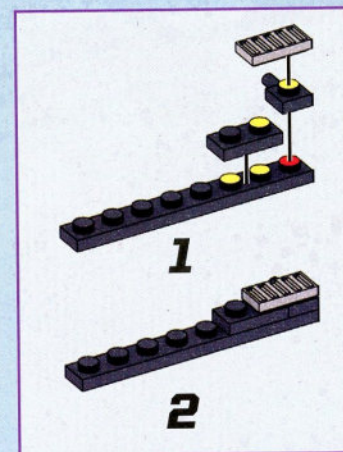
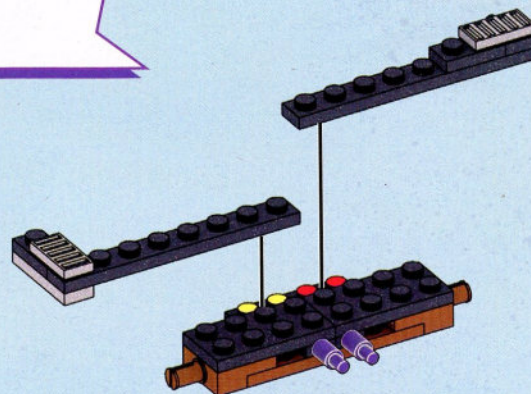
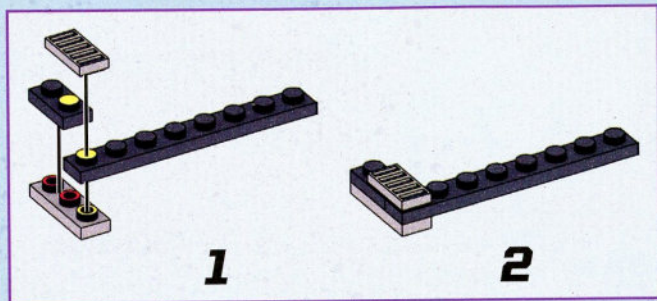
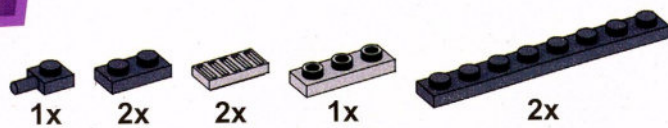

18

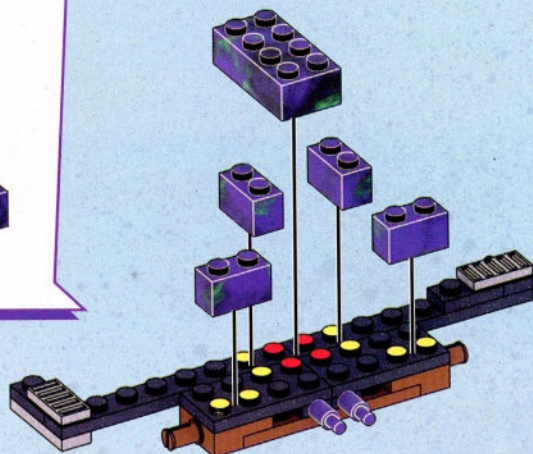

19

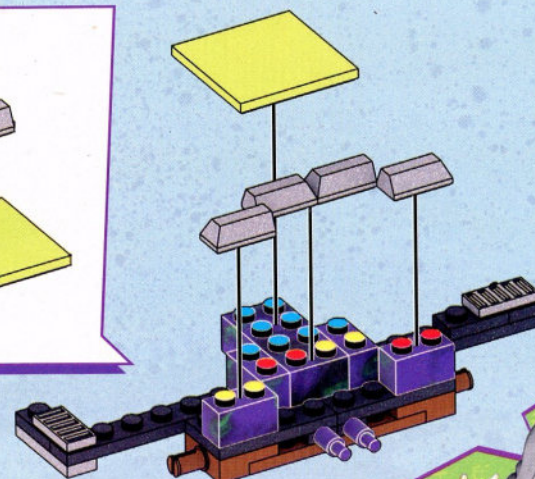
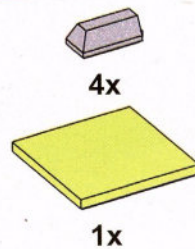

20



2x

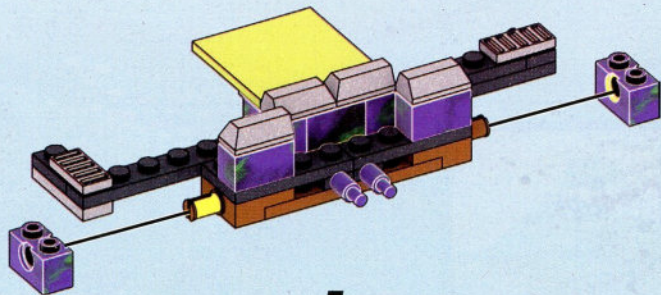

1

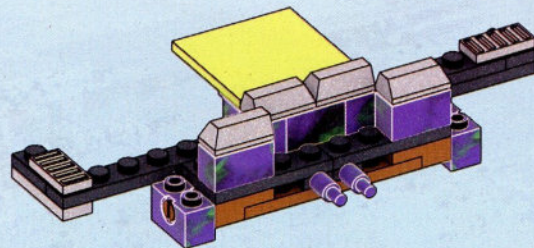

2

21

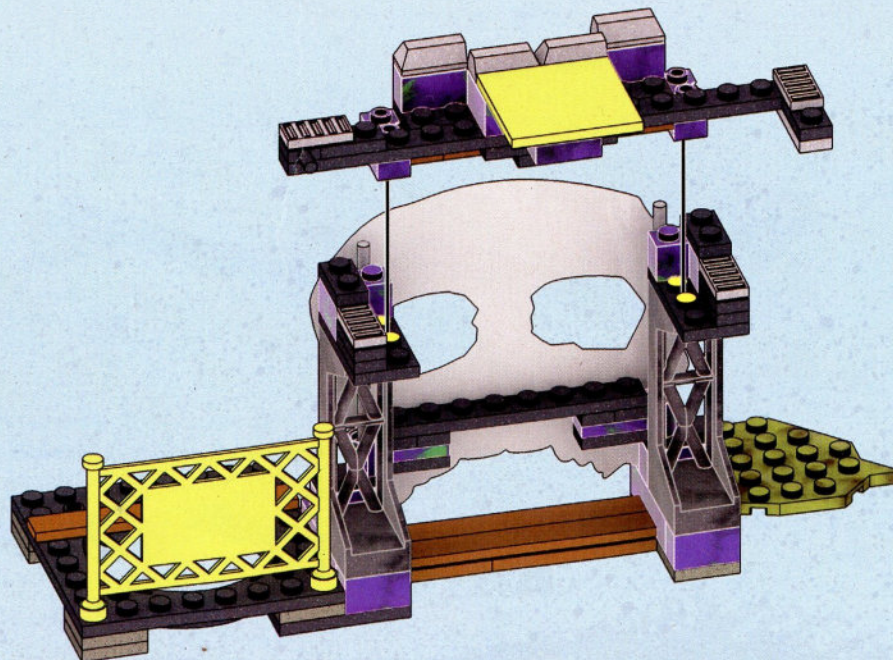

22



2x

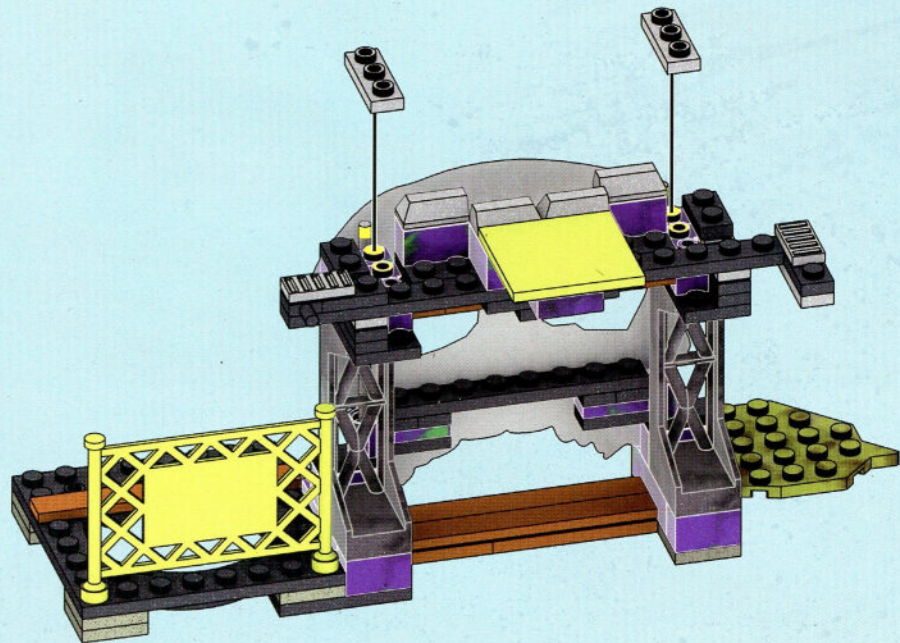

23



2x



2x

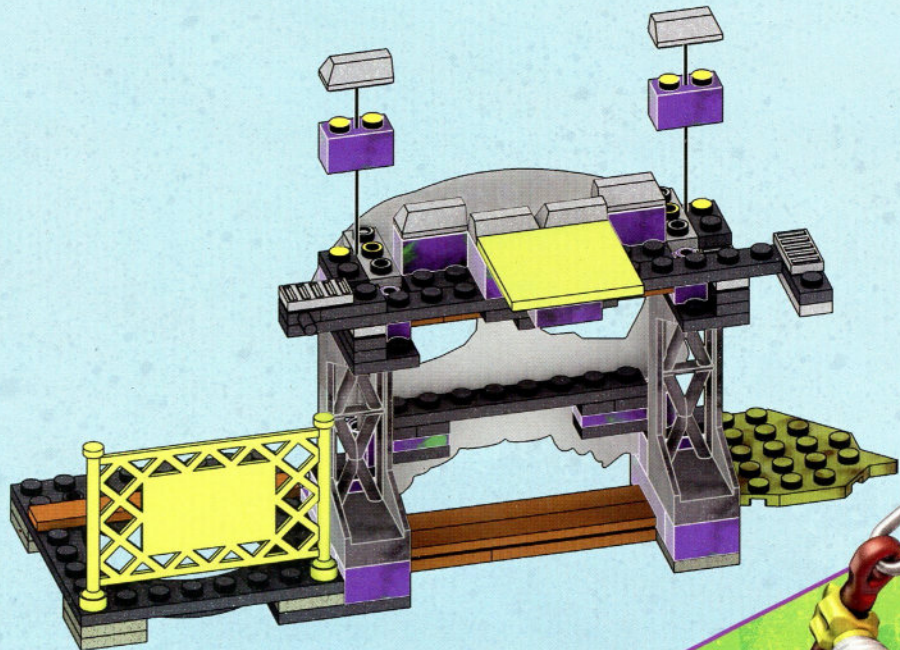

24

1x



1x



1x

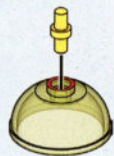

1



2

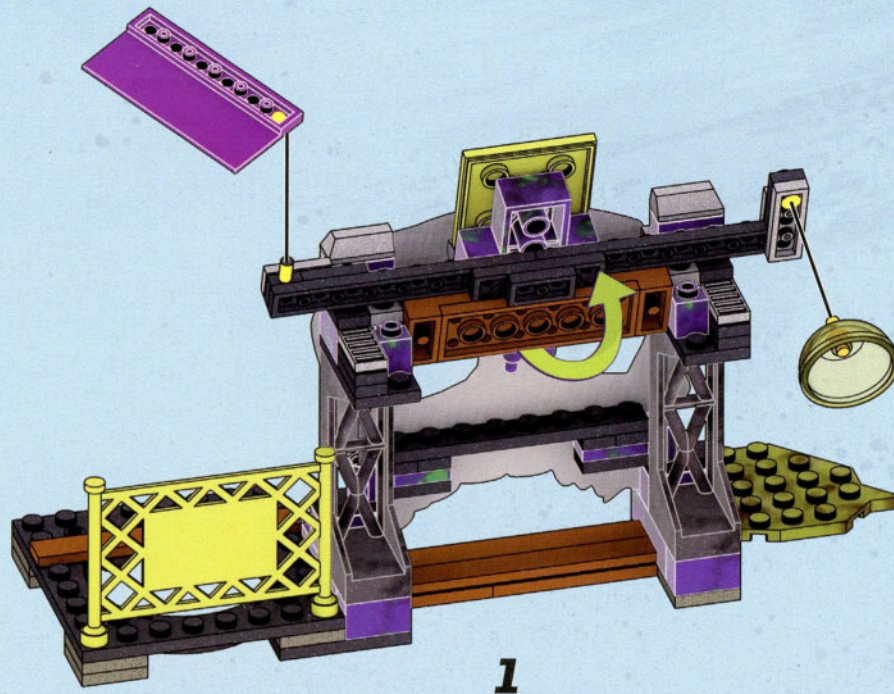

1

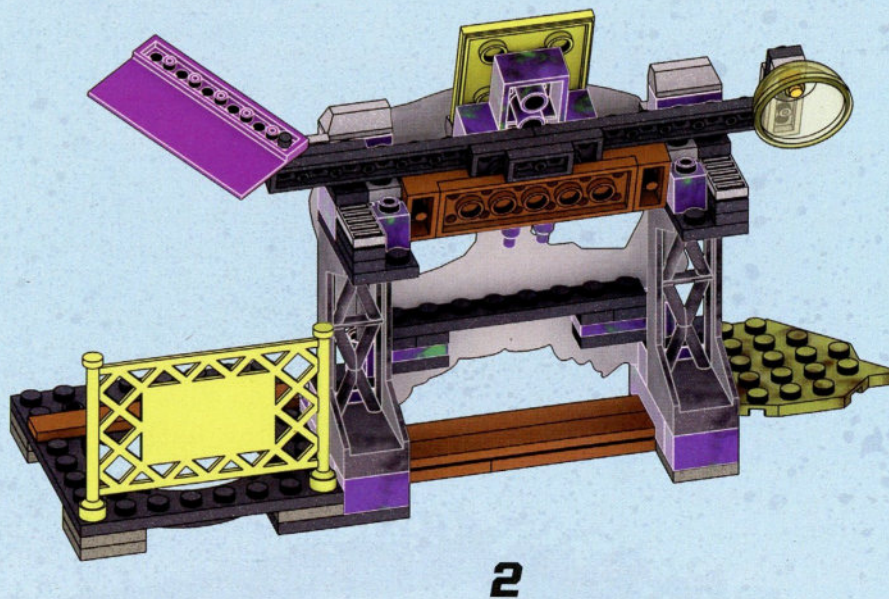

2

25

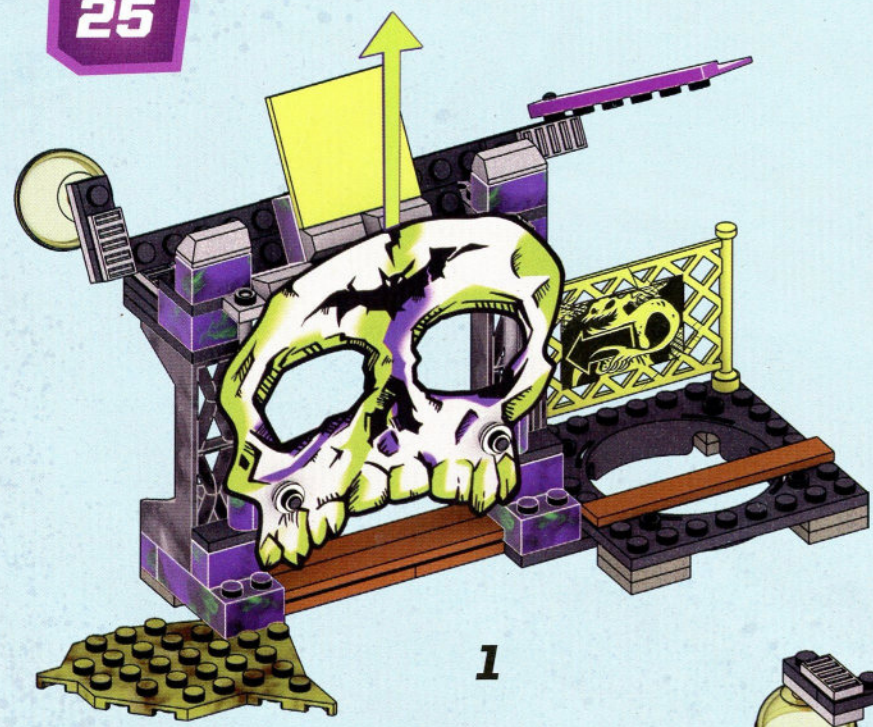

1

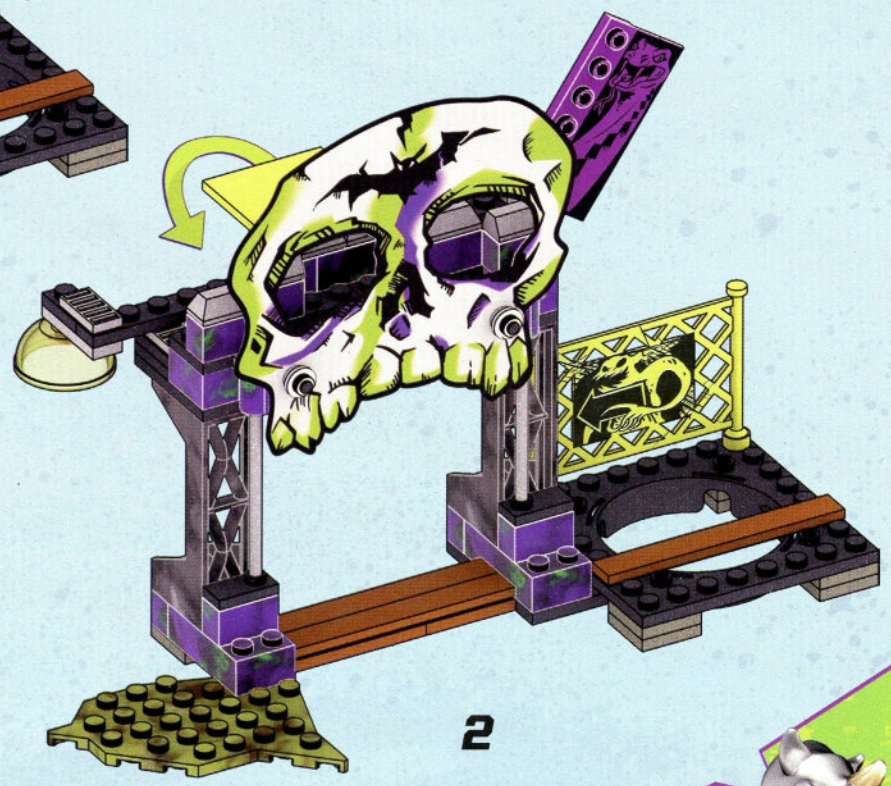

2



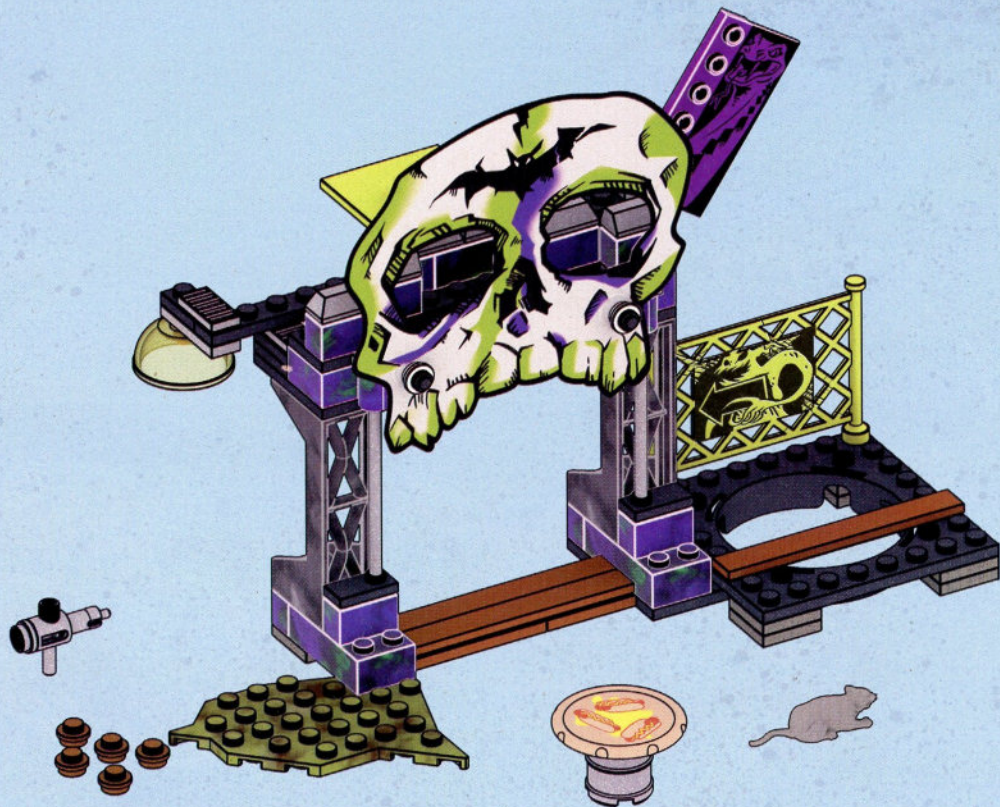

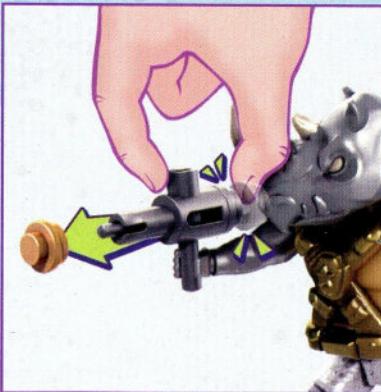
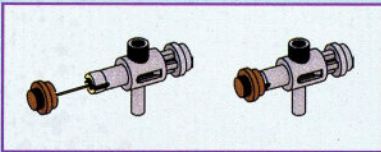
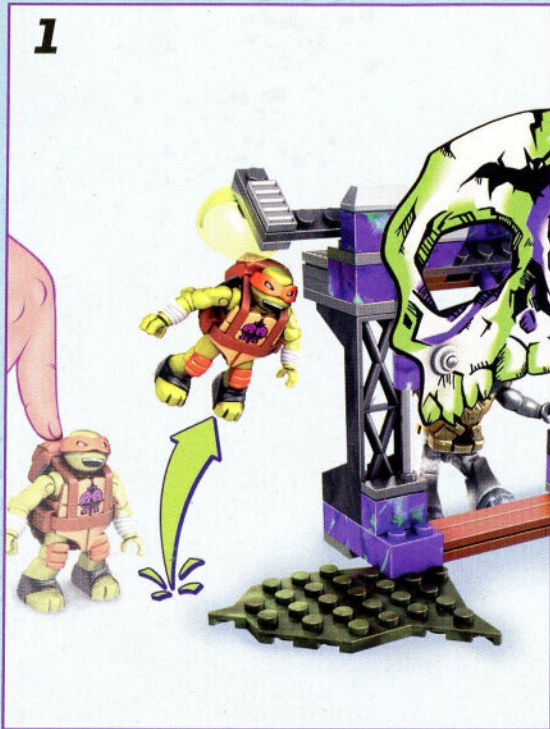

Warning: Do not aim at eyes or face. Only use projectiles supplied with this toy. Do not fire at point blank range.
 Attention : Ne pas viser les yeux ou le visage. Ne pas utiliser d'autres projectiles que ceux fournis avec ce jouet. Ne pas tirer à bout portant.
 Advertencia: No apuntar hacia los ojos o la cara. Utilizar exclusivamente los proyectiles suministrados con este juguete. No disparar a quemarropa.
 Atenção: Não apontar em direção aos olhos ou ao rosto. Usar apenas os projéteis fornecidos com este brinquedo. Não disparar à queima-roupa.
 Avvertenza: Non mirare agli occhi o al viso. Usare solo i proiettili forniti con il giocattolo. Non sparare a distanza ravvicinata.
 Achtung: Nicht auf Augen oder Gesicht zielen. Nur die zu diesem Spielzeug gehörenden Projektile verwenden. Nicht auf Menschen oder Tiere oder aus nächster Nähe zielen.
 Ostrzeżenie: Nie celuj w oczy i twarz. Nie strzelaj pociskami innymi niż dostarczone z zabawką. Nie strzelaj z bliska.
 Waarschuwing: niet op ogen of gezicht richten. Gebruik uitsluitend de bijgeleverde projectielen. Niet van te dichtbij afschieten.
 Предупреждение: Не направляйте в глаза или лицо. Используйте только снаряды, входящие в комплект. Не стреляйте со слишком близкого расстояния.
 Advarsel: Sigt ikke mod øjne eller ansigt. Brug kun de projektiler, som følger med legetøjet. Skyd ikke direkte på personer eller ting.
 Varning: Sikta inte mot ögon eller ansikte. Använd endast projektiler som medföljer leksaken. Fyra inte av på mycket nära håll.
 Advarsel: Du må ikke sikte mot øyne eller ansikt. Bruk bare prosjektilene som følger med leken. Ikke skyt på noe på kloss hold.
 Varoitus: Älä tähtää silmiin äläkä kasvoihin. Käytä ainoastaan tämän tuotteen mukana tulleita ammuksia. Älä ammu lähietäisyydeltä.
 Προσοχή: Μην στοχεύετε στα μάτια ή στο πρόσωπο. Χρησιμοποιείτε μόνο τα βλήματα που περιλαμβάνονται. Μην στοχεύετε όταν δεν έχετε ορατότητα.
 Uyarı: Göze veya yüze nişan almayın. Fırlatmak için yalnızca bu oyuncakla birlikte verilen objeleri kullanın. İnsanlara ve hayvanlara nişan almayın.
 警告：請勿對着眼睛或臉部分射。僅使用本玩具自帶的拋射物。請勿近距離射擊。
 警告：目や顔を狙わないでください。このおもちゃに同梱されている発射物のみ使用するようになしてください。到達可能な距離内で火を燃やさないでください。
 تحذير: يجب عدم التصويب باتجاه العينين أو الوجه. يجب استخدام المقذوفات المزودة مع هذه اللعبة فقط. يجب عدم الإطلاق من مدى قريب.





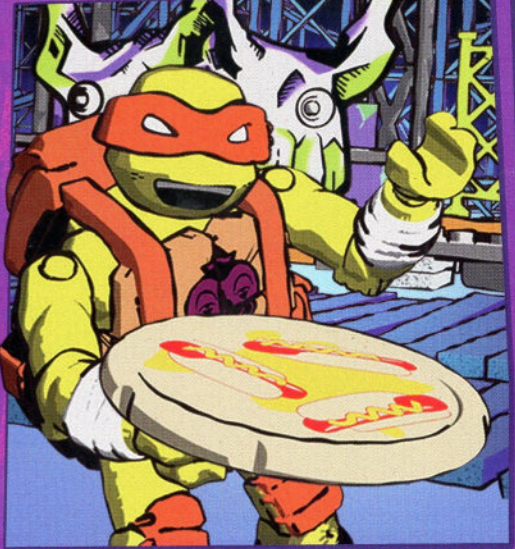

YOU CAN COLLECT THEM ALL!
 À COLLECTIONNER! | COLECCIONALOS
 TODOS! | COLEZIONE TUTTI!
 DU KANNST SIE
 COLLEZIONALI TUTTI!
 ALLE SAMMELN! | MOŻESZ ZEBRAĆ JE
 WSZYSTKIE! | VERZAMEL ZE ALLEMAAL!
 ТЫ МОЖЕШЬ СОБРАТЬ ИХ ВСЕХ! | ΣΥΛΛΟΓΗ!
 HEPSİNİ BİRİKTİR! | إجمعتك جمعها كلها!

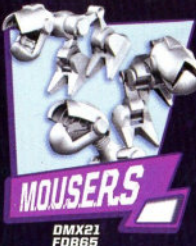

COLLECT & CONNECT! COLLECTIONNE-LES ET COMBINE-LES!
 ! COLECCIONA Y CONECTA! COLECCIONA E UNE! COLLEZIONA
 E COLLEGA! ZUM SAMMELN UND VERBINDEN! ZBIERAJ I
 ŁĄCZ! VERZAMEL & COMBINEER! СОБИРАЙ И СОЕДИНЯЙ!
 ΚΑΝΤΕ ΣΟΥΠΕΡ ΣΥΛΛΟΓΗ & ΕΝΩΣΤΕ! HEPSİNİ BİRİKTİR VE
 BİRLEŞTİR! اجمع ووصل!



Each sold separately and subject to availability. / Tous vendus séparément. Certains produits peuvent ne pas être commercialisés. / Se venden por separado y están sujetos a disponibilidad. / Vendidos em separado e sujeitos à disponibilidade. / Ognuno in vendita separatamente secondo disponibilità. / Alle Artikel separat erhältlich. Einige Artikel werden nicht in allen Ländern vertrieben. / Sprzedawane oddzielnie w zależności od dostępności. / Per stuk verkrijgbaar en niet overal leverbaar. / Каждый продукт продается отдельно, в зависимости от наличия. / Sælges separat og så længe lager haves. / Alla delar säljs separat så långt lagret räcker. / Hver leke selges separat så langt lageret rekker. / Jokainen myydaän erikseen, saatavuus voi vaihdella. / Το καθένα πωλείται ξεχωριστά και ανάλογα με τη διαθεσιμότητα. / Her biri ayrı ayrı ve stoklara bağlı olarak satılır. / 每件单独出售，并且视库存情况而定。 それぞれ在庫状況に従って個別に販売されます。 / تباع كل منها على حدة وتخضع لتوفرها.

MEGA CONSTRUX™

Build beyond™

Au-delà de la construction !

¡Construye sin límites!

Mais do que Construção!

Costruisci oltre ogni limite!

Es gibt keine Grenzen!

Więcej niż budowanie!

Meer dan alleen bouwen!

Больше, чем конструктор!

Χτίσε έναν ολόκληρο κόσμο!

Hayallerini İnşa Et

لبنني .. وأكثر!



play.megaconstrux.com

