

nickelodeon™  
TEENAGE MUTANT NINJA  
TURTLES



Turtle Sewer Lair | Coffret Égouts  
Guarida de alcantarillado de Tortugas Ninja  
Esgotos das Tartarugas | Covo delle Fogne | Turtles  
Kanalisationsversteck | Kryjówka żółwi w kanałach  
Turtle Riolschuilplaats | Логово черепах



33



1x



3x



1x



1x



1x

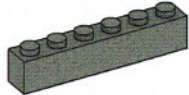

1x

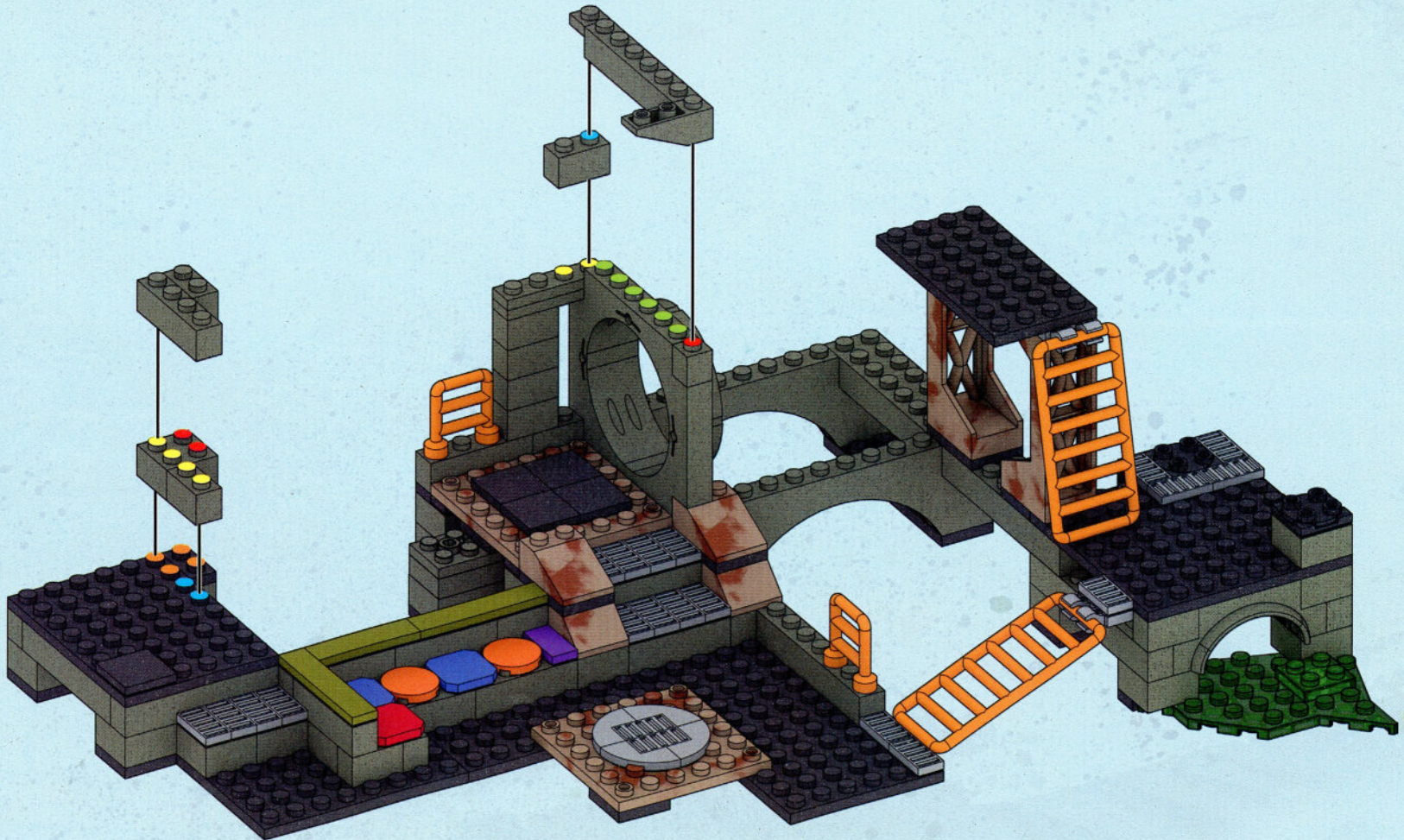

34



1x



1x



1x



2x

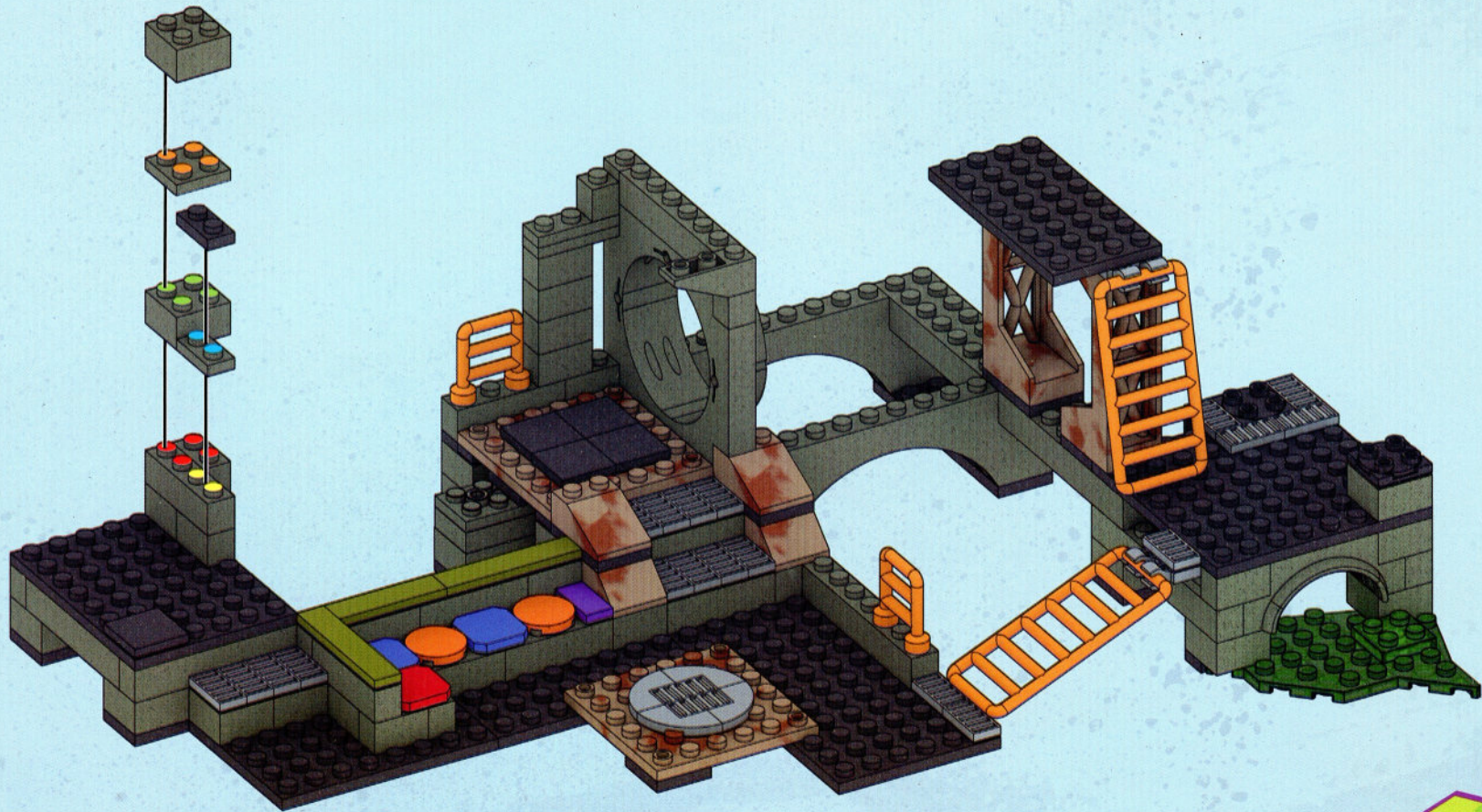

35



1x



1x



1x



1x



1x



1x

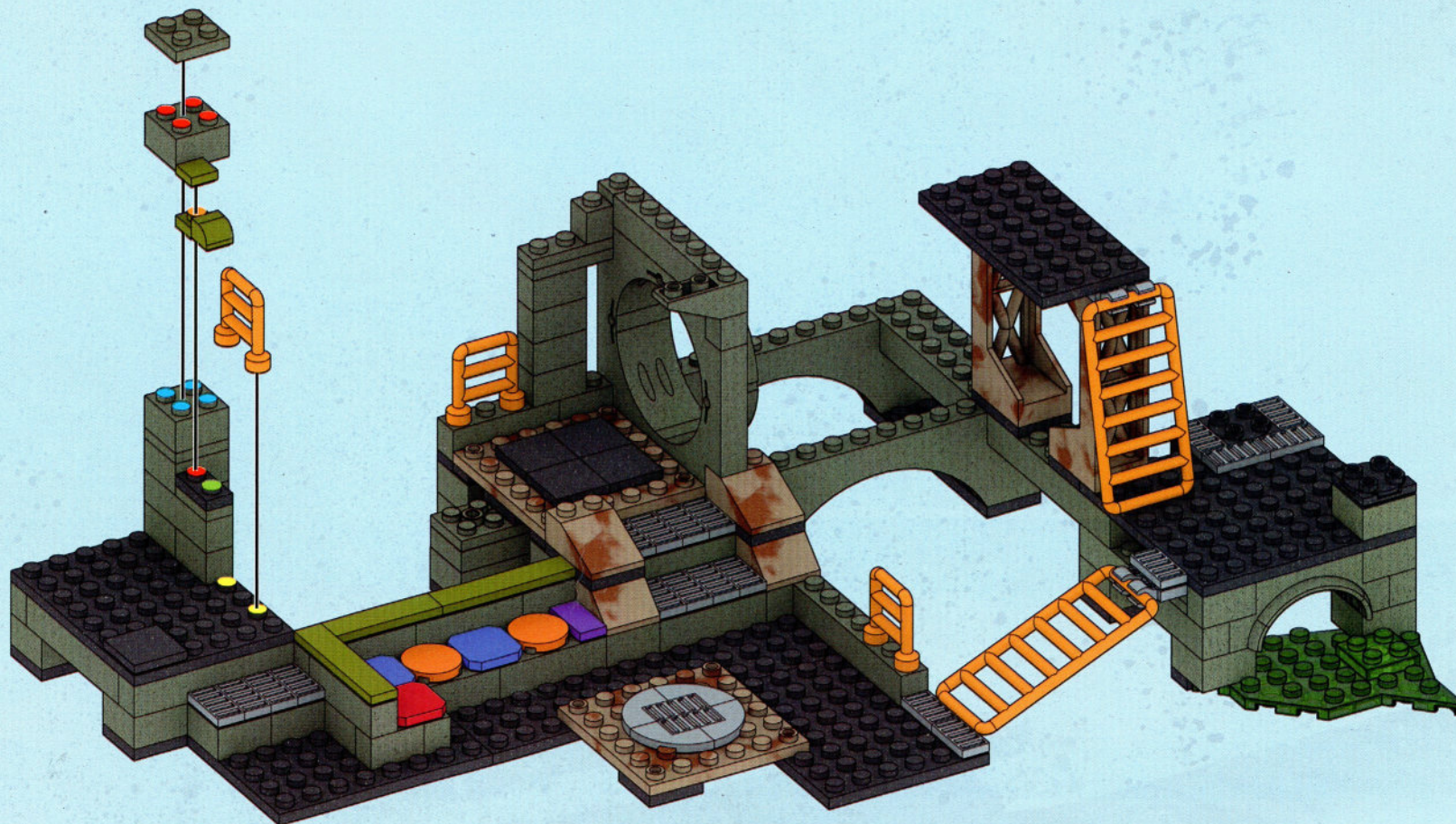

36



1x



2x



1x

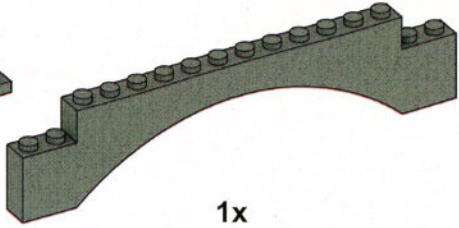

1x

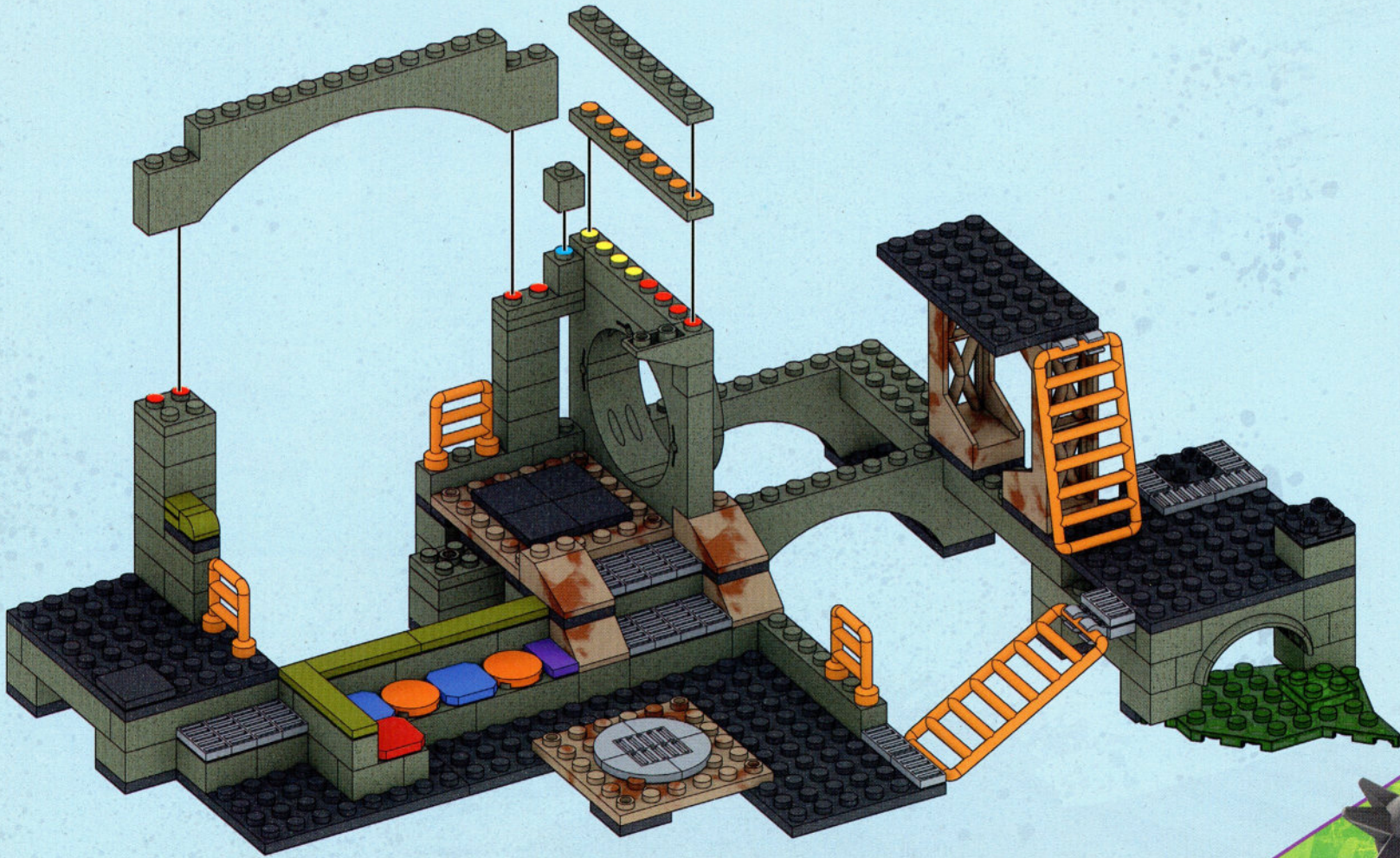

37

- 1x
- 1x
- 1x
- 1x
- 1x
- 1x
- 2x
- 1x

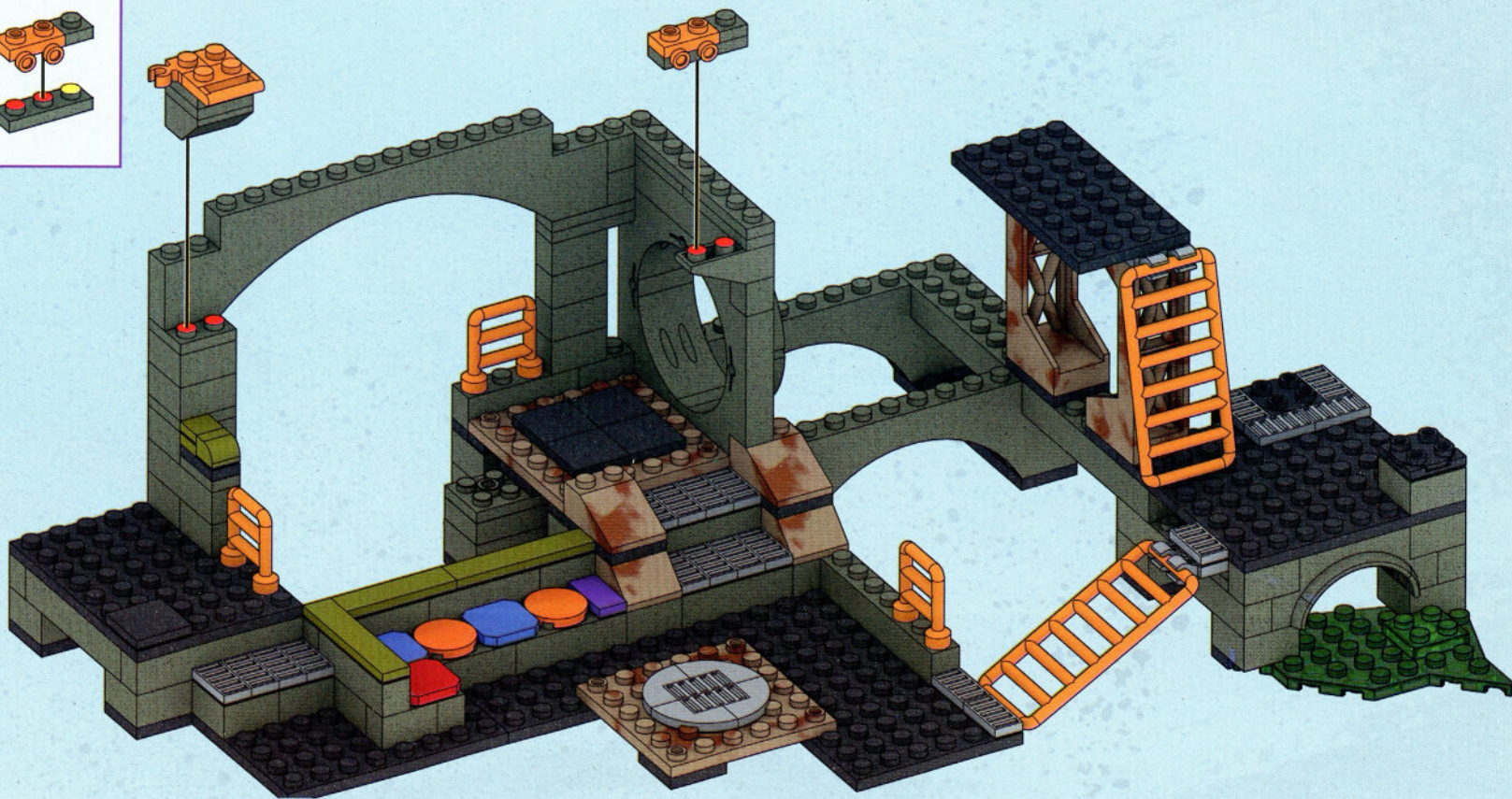
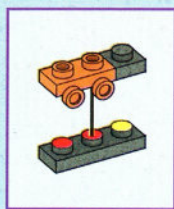
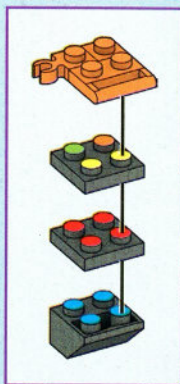



1x

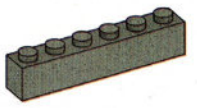

1x



1x

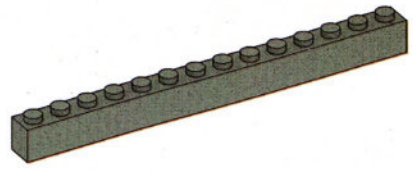

1x

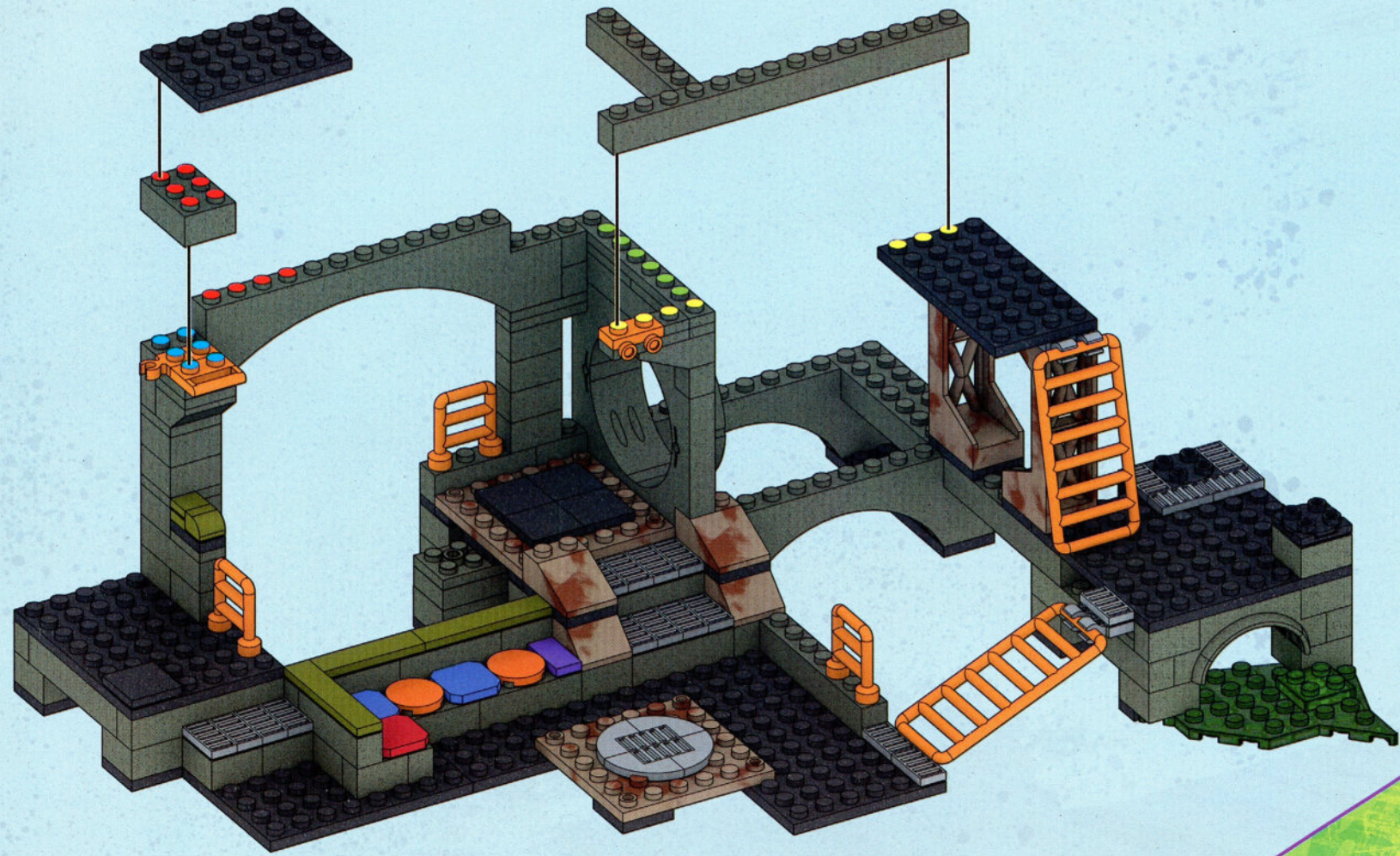

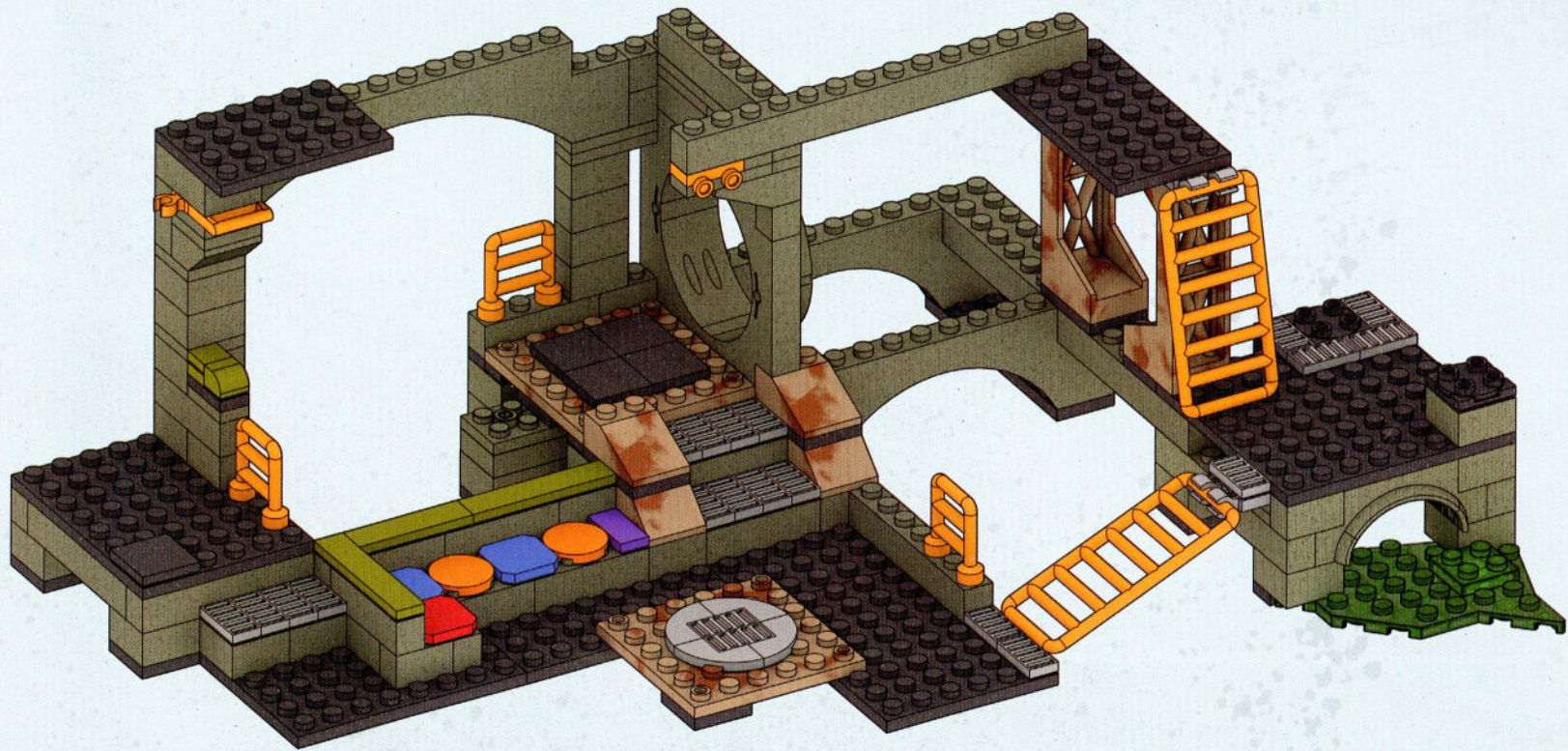



40



1x



2x

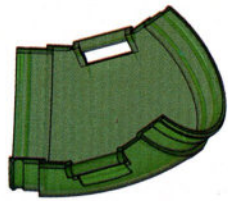

2x

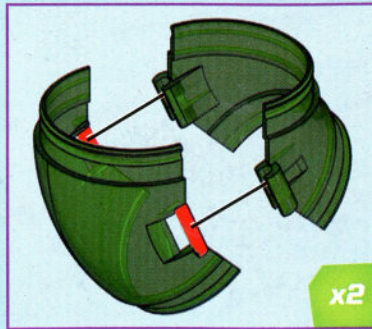

1

Click!

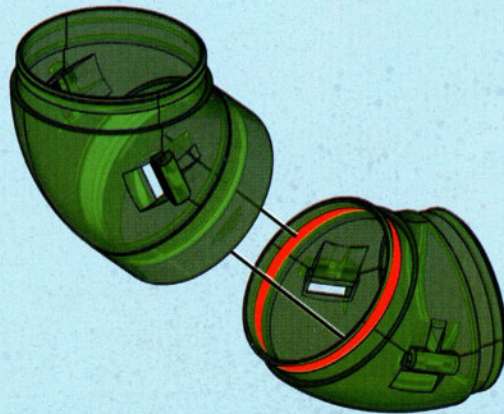

2

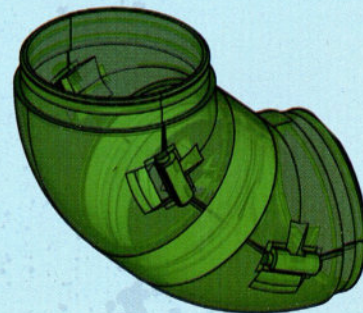

3



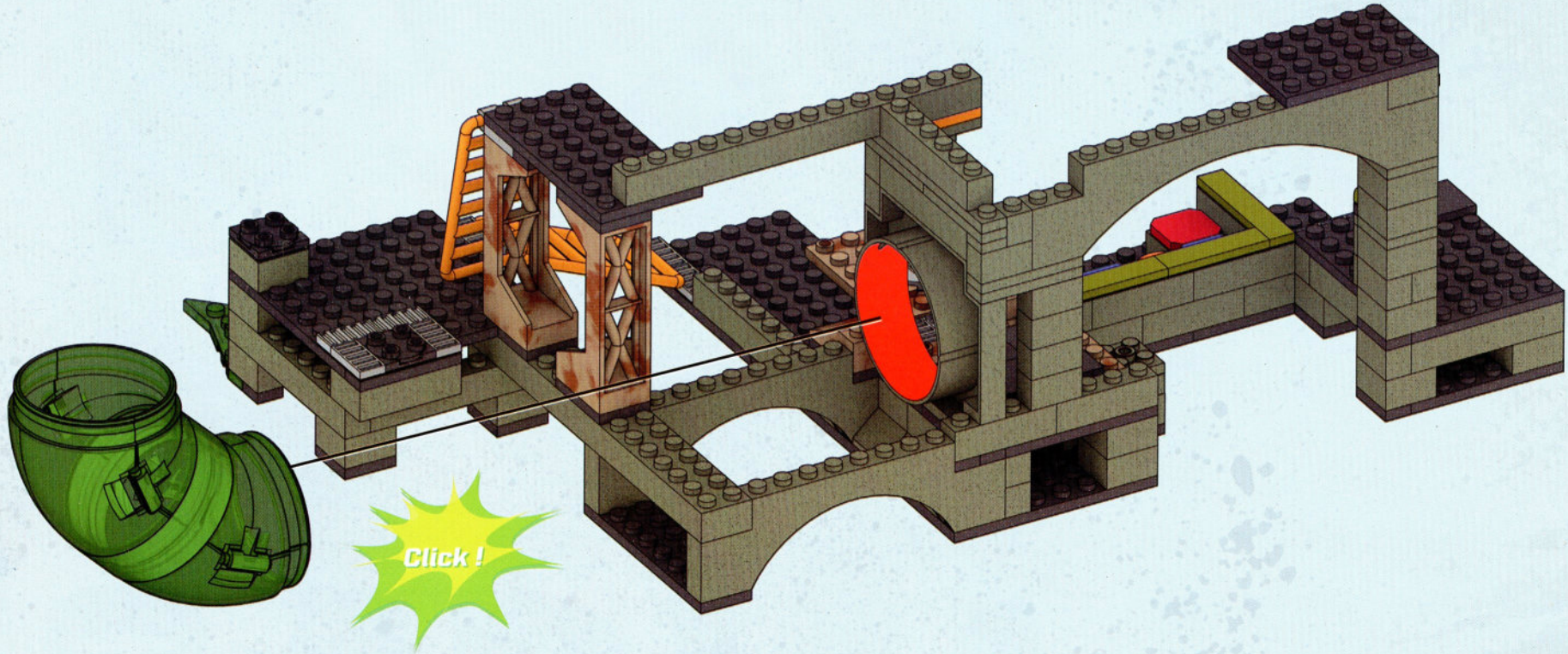

42

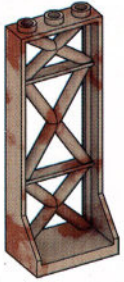

1x

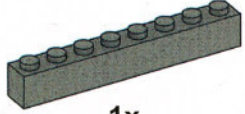

1x

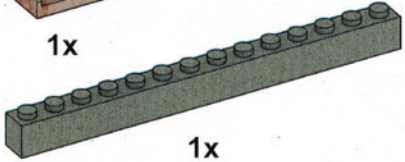

1x

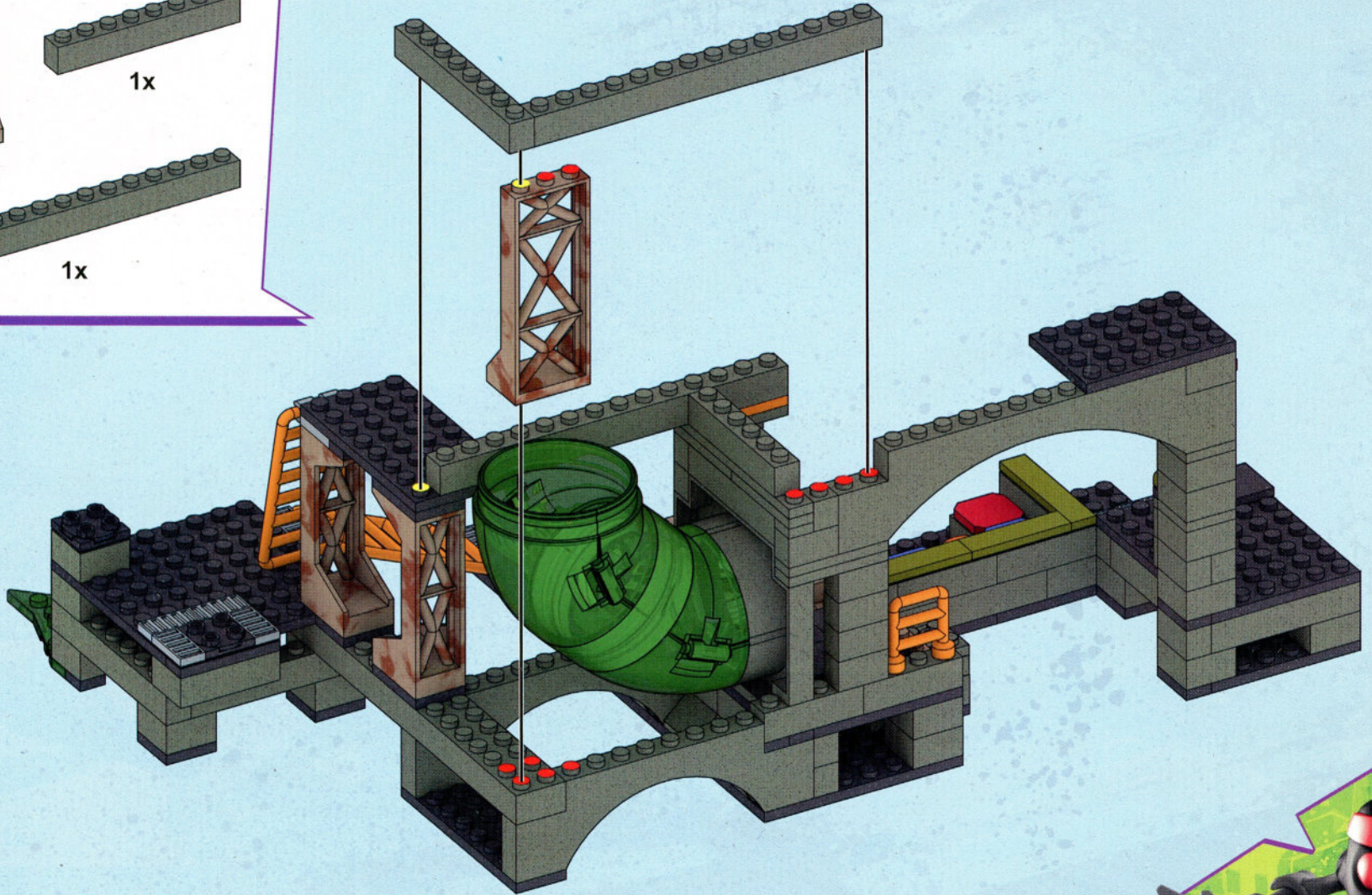

43



1x



1x

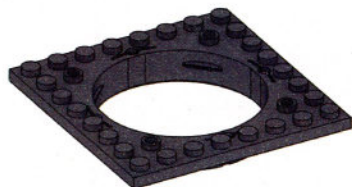

1x

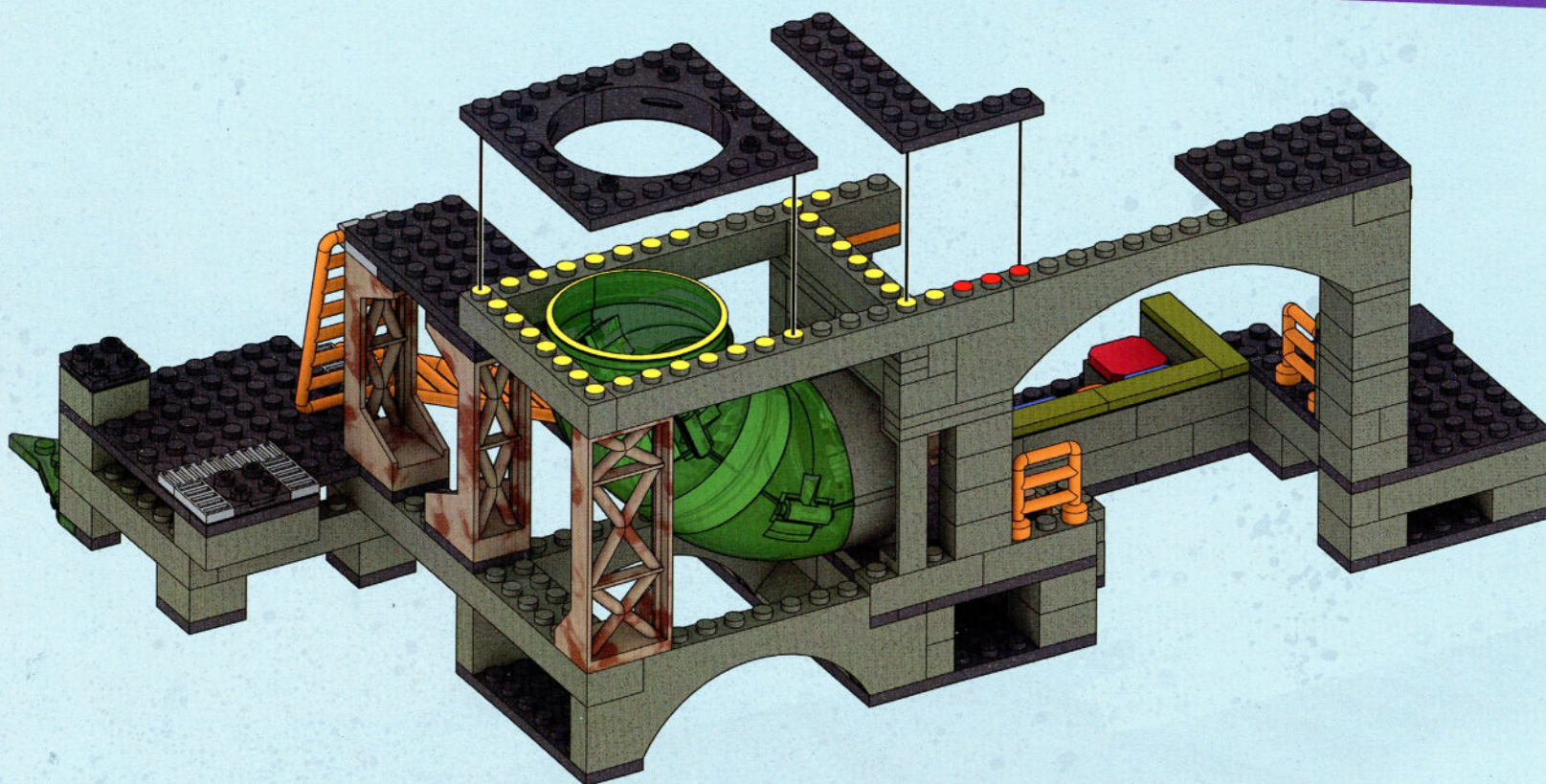
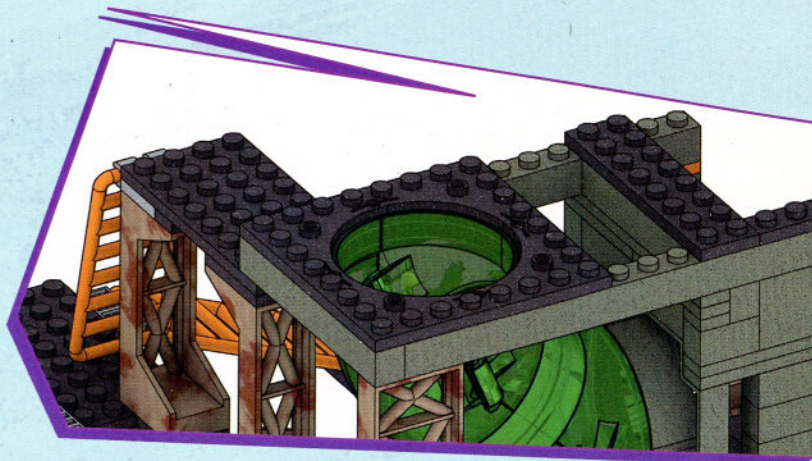

44



1x

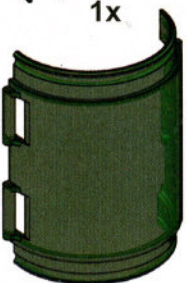

1x



1x

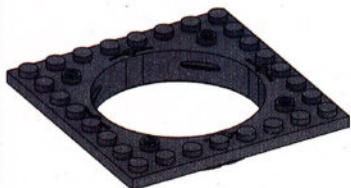

1x

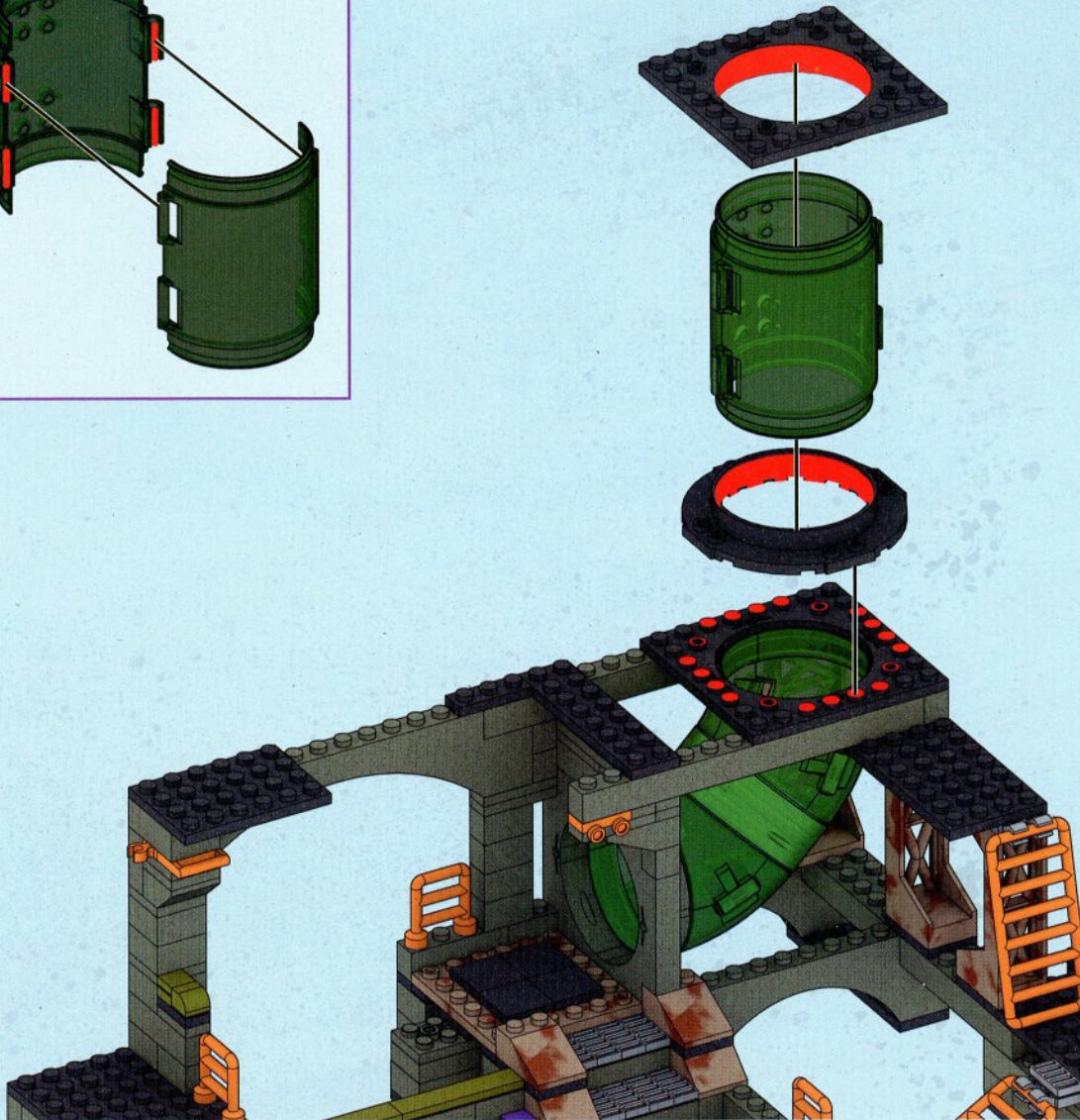
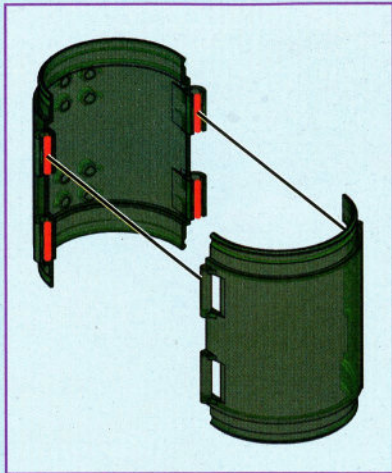

45



1x



1x



1x



1x



2x



1x



1x

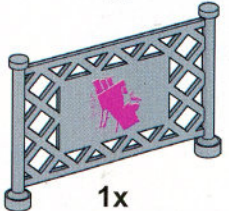

1x

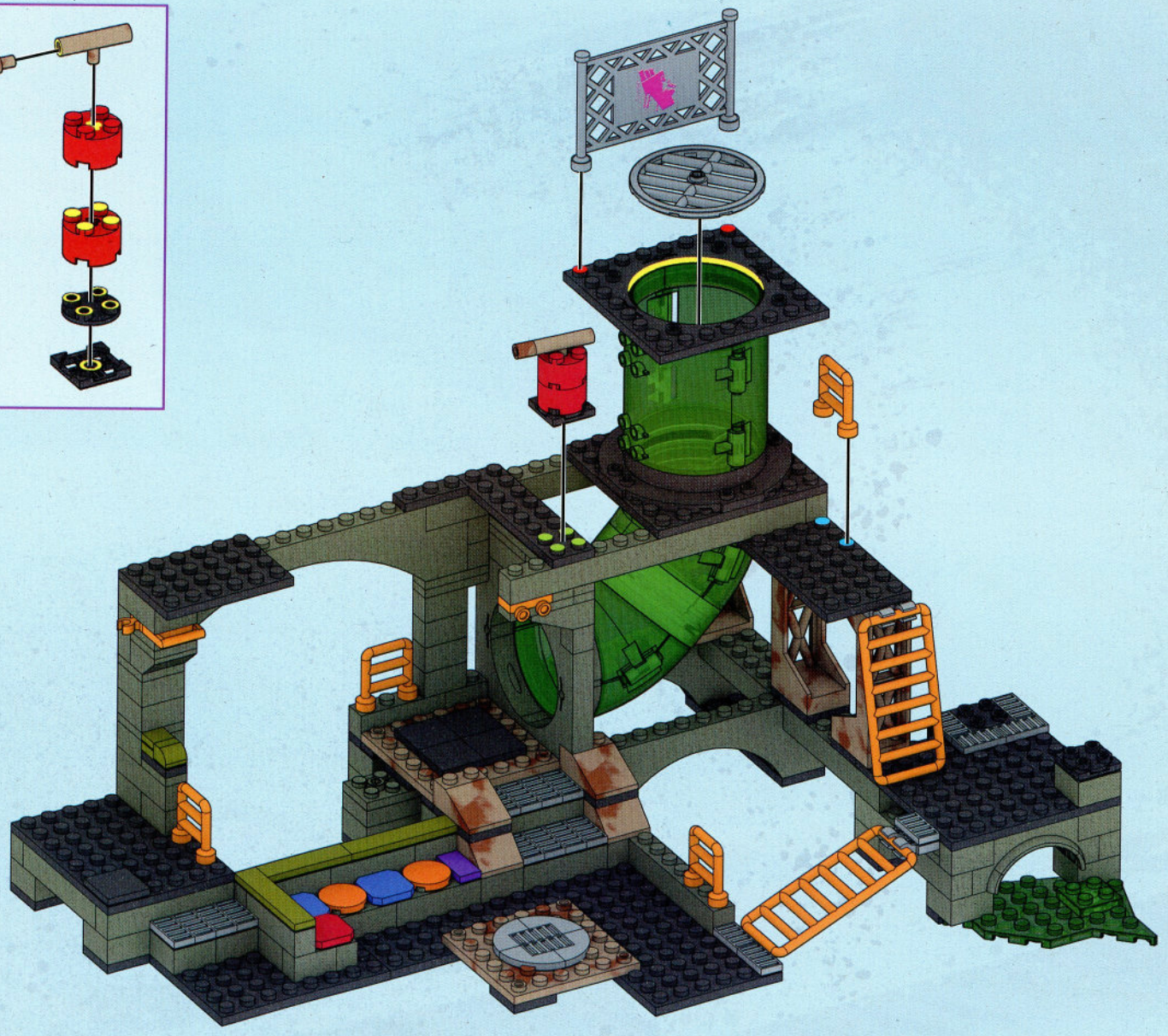
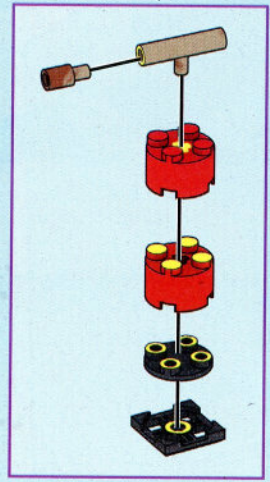

46

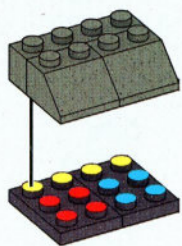
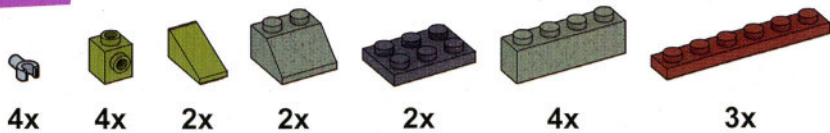

1

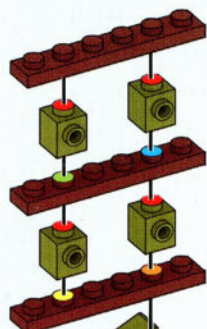

3

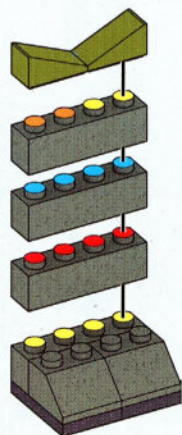

2

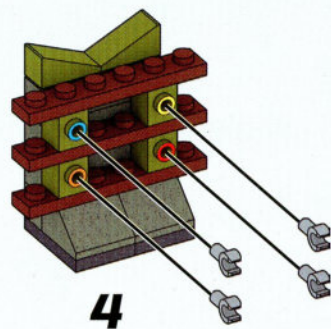

4



47

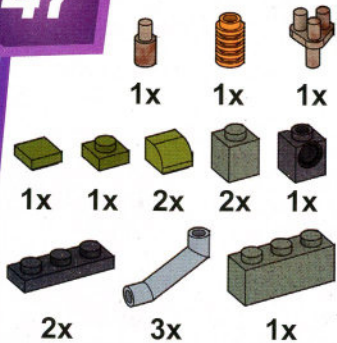

48

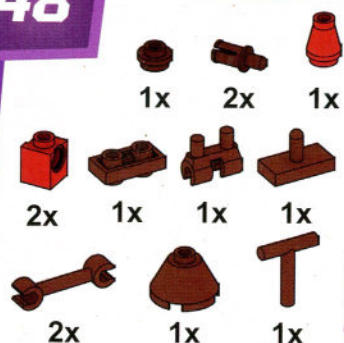

49

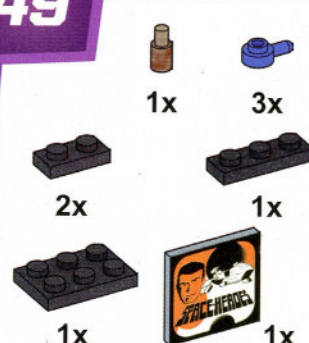

50

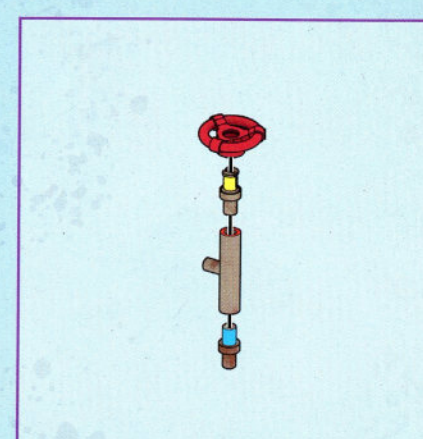
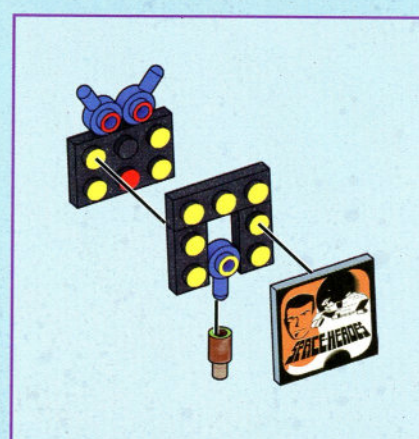
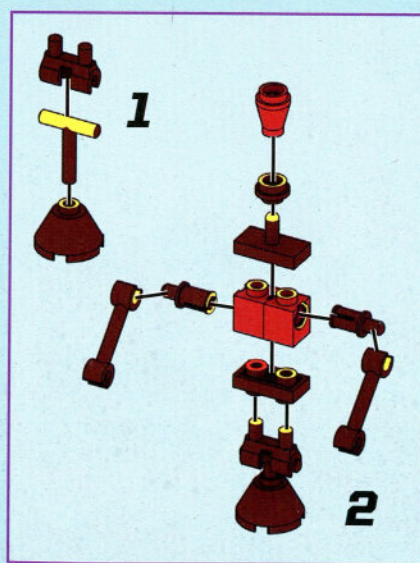
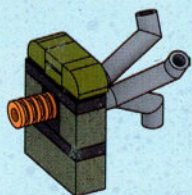
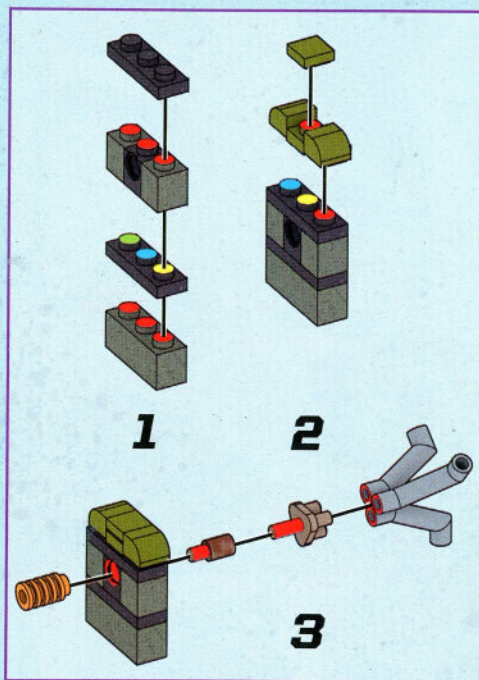



51



1x

47



50



49



48

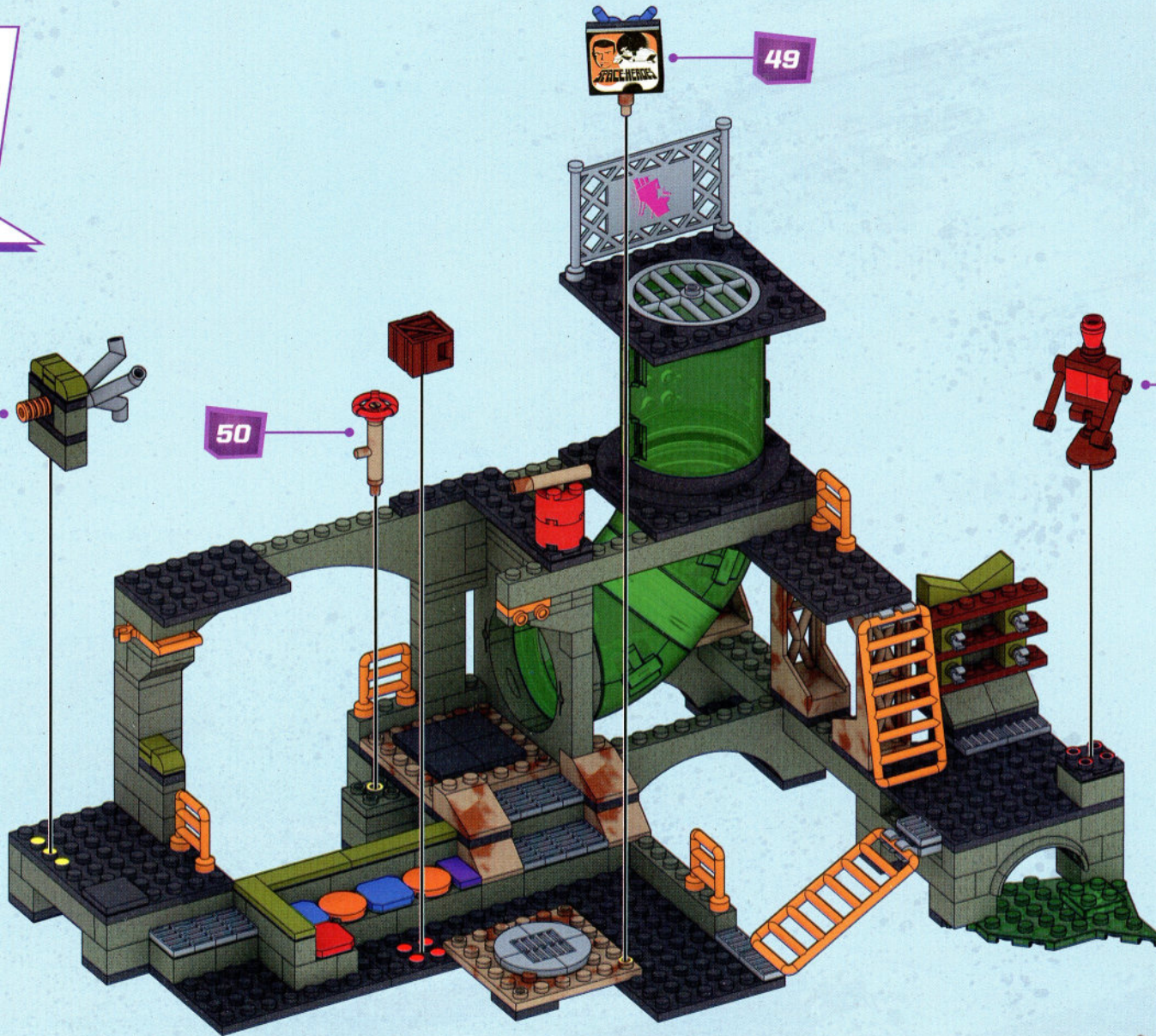
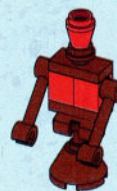

52



1x



1x



1x



2x



1x



1x



1x

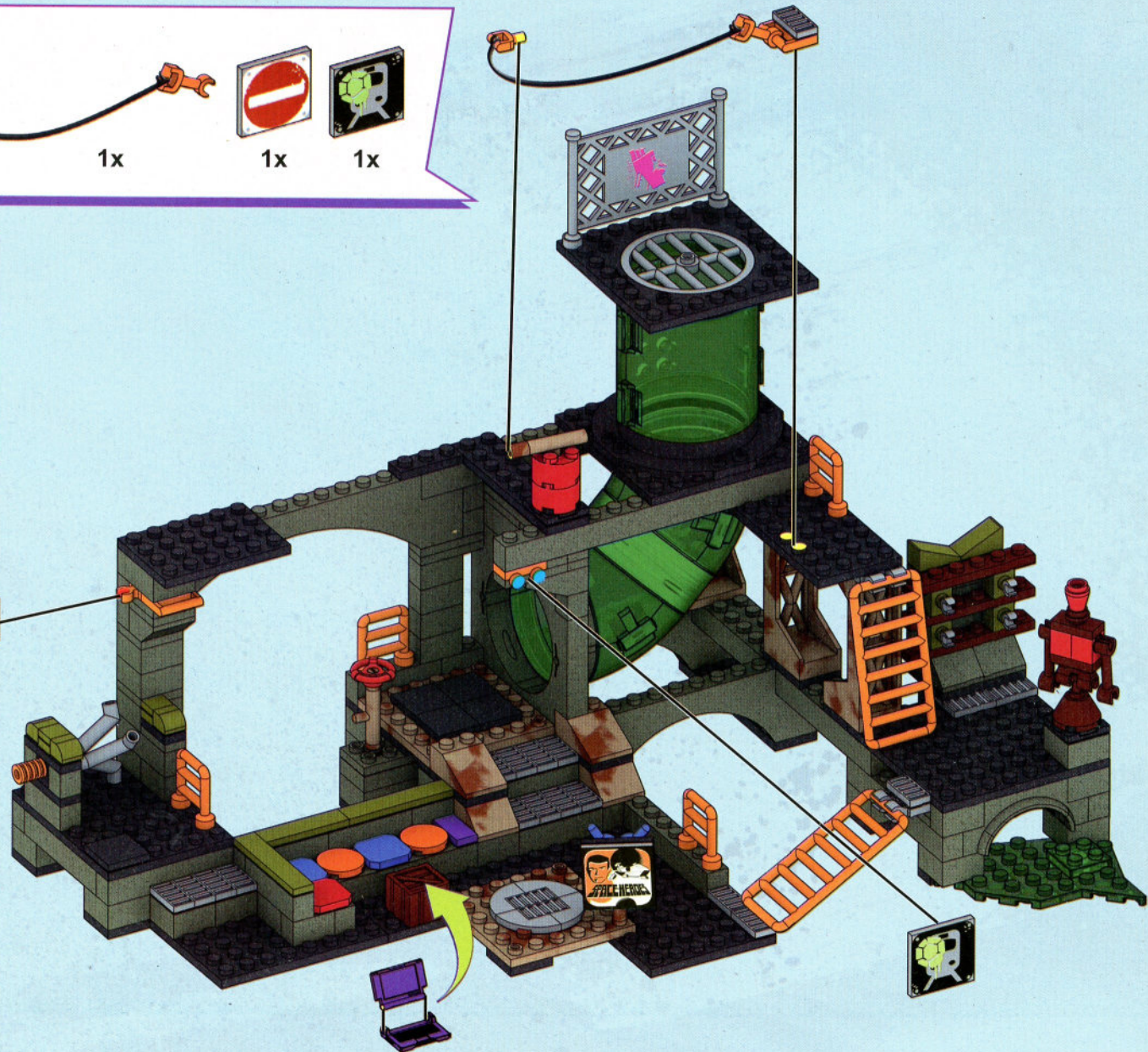
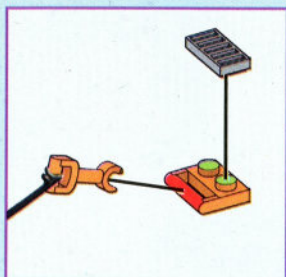
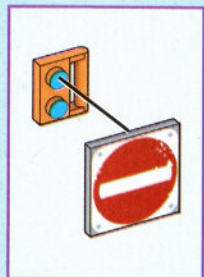



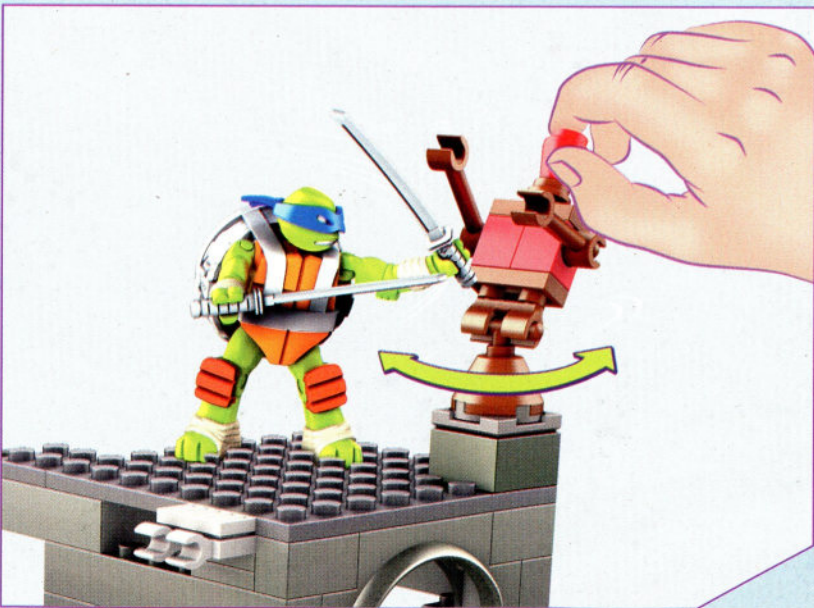
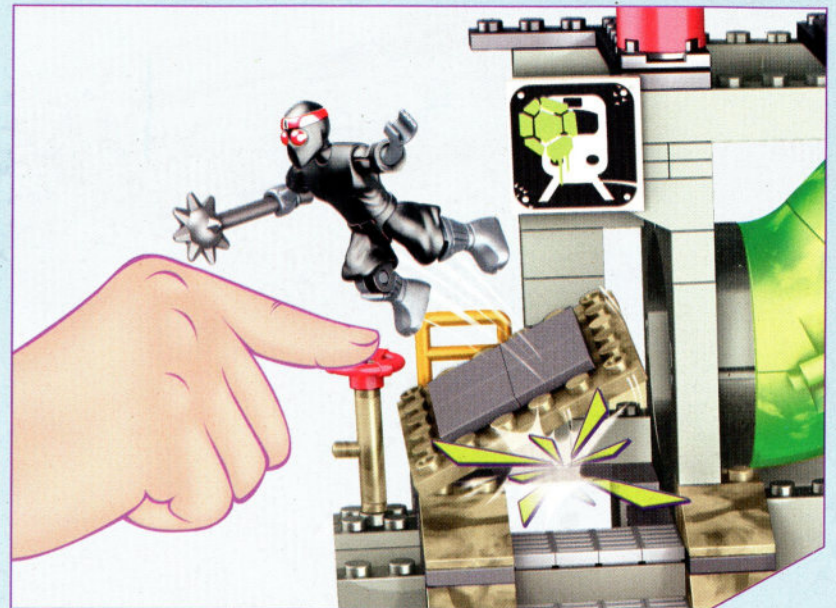



Warning: Do not aim at eyes or face. Only use projectiles supplied with this toy. Do not fire at point blank range.

Attention : Ne pas viser les yeux ou le visage. Ne pas utiliser d'autres projectiles que ceux fournis avec ce jouet. Ne pas tirer à bout portant.

Advertencia: No apuntar hacia los ojos o la cara. Utilizar exclusivamente los proyectiles suministrados con este juguete. No disparar a quemarropa.

Atenção! Não apontar para os olhos e para a face. Não utilizar projéteis diferentes dos providos. Não disparar excessivamente perto do alvo.

Attenzione: Non puntare agli occhi o al viso. Usa solo i proiettili forniti con il giocattolo. Non sparare a distanza ravvicinata.

Achtung: Nicht auf Augen oder Gesicht zielen. Nur die zu diesem Spielzeug gehörenden Projektile verwenden. Nicht auf Menschen oder Tiere oder aus nächster Nähe zielen.

Ostrzeżenie: Nie celuj w oczy ani w twarz. Używaj wyłącznie rzutek BOOMco.™. Nie strzelaj z bliska.

Waarschuwing: niet op ogen of gezicht richten. Gebruik uitsluitend de bijgeleverde projectielen. Niet van te dichtbij afschieten.

Предупреждение: Не направляйте в глаза или лицо. Используйте только детали, входящие в комплект. Не стреляйте со слишком близкого расстояния.

Advarsel: Sigst ikke mod øjne eller ansigt. Brug kun de projektiler, som følger med legetøjet. Skyd ikke direkte på personer eller ting.

Varning! Sikta inte mot ögon eller ansikte. Använd endast projektiler som medföljer leksaken. Fyra inte av på mycket nära håll.

Advarsel: Du må ikke sikte mot øyne eller ansikt. Bruk bare prosjektilene som følger med leken. Ikke skyt på noe på kloss hold.

Varoitus: Älä tähtää silmiin äläkä kasvoihin. Käytä ainoastaan tämän tuotteen mukana tulleita ammuksia. Älä ammu lähietäisyydeltä.

Προσοχή: Μη στοχεύετε στα μάτια ή στο πρόσωπο. Χρησιμοποιείτε μόνο τα βλήματα που περιλαμβάνονται. Μη στοχεύετε προς ανθρώπους ή ζώα.

تحذير: يجب عدم التصويب باتجاه العينين أو الوجه. يجب استخدام المقذوفات المزودة مع هذه اللعبة فقط. يجب عدم الإطلاق من مدى قريب.

警告: 请勿对着眼睛或脸部发射。仅使用本玩具自带的发射物。请勿近距离射击。

警告: 目や顔を狙わないでください。このおもちゃに同梱されている発射物のみ使用するようにしてください。到達可能な距離内で火を燃やさないでください。



**TURTLE POWER | PODER DE TORTUGA NINJA**  
**PODER DAS TARTARUGAS NINJA | МОЦ ŻÓЉИ**  
**СИЛА ЧЕРЕПАШЕК**



**ZIPLINE ACTION! | ACTION SUR FILIN!**  
**¡ACCIÓN DE CUERDA DE ESCAPE!**  
**ANDA DE SLIDE! | AZIONE ECCLATANTE!**  
**SEIL-ACTION! | TYROLKA!**  
**ZIPLIJNASTIE! | СКОРОСТНОЙ СПУСК!**



**DOUBLE SLASHING ACTION!**  
**ACTION DOUBLE FRAPPE!**  
**¡ACCIÓN DE DOBLE ATAQUE!**  
**DUPLO ATAQUE!**  
**DOPPIA AZIONE DEVASTANTE!**  
**DOPPELTE SCHLAG-ACTION!**  
**PODWÓJNE CIĘCIE!**  
**DUBBELE ACTIE!**  
**ДВОЙНЫЕ УДАРЫ!!**

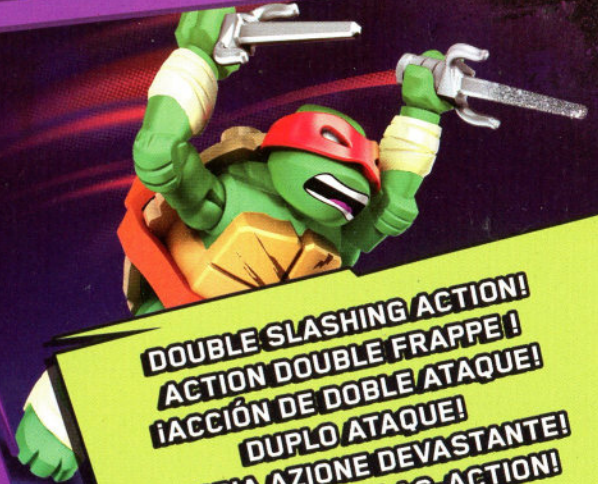

**SLASHING ACTION! | ACTION DE FRAPPE!**  
**¡ACCIÓN DE ATAQUE! | MOVIMENTOS DE BRAÇOS!**  
**AZIONE DEVASTANTE! | SCHLAG-ACTION!**  
**CIĘCIE! | WAT EEN ACTIE! | ФУНКЦИЯ УДАРОВ!**



YOU CAN COLLECT THEM ALL! | À COLLECTIONNER!  
 ¡COLECCIONALOS TODOS! | COLEZIONE TODOS!  
 COLLEZIONALI TUTTI! | DU KANNST SIE ALLE SAMMELN!  
 MOŻESZ ZEBRAĆ JE WSZYSTKIE! | VERZAMEL ZE  
 ALLEMAAL! | ТЫ МОЖЕШЬ СОБРАТЬ ИХ ВСЕХ!



**DONNIE™**

DMX21



**FOOT SOLDIER™**

DMX21



**KRAANG™**

DMX21



**LEO™**

DMX21



**RAPH™**

DMX21



**MIKEY™**

DMX21



**SHREDDER™**

DMX21



**MIKEY™**

DMX27



**RAPH™**

DMX32



**LEO™**

DMX34



**RAPH™**

DMX35



**DONNIE™**

DMX37



**MIKEY™**

DMX38



**BAXTER™**

DMX50



**FOOT SOLDIER™**

DMX50



**LEO™**

DMX50



**MIKEY™**

DMX51



**MOUSERS™**

DMX51



**CASEY JONES™**

DMX52



**DONNIE™**

DMX52



**RAPH™**

DMX54



**SHREDDER™**

DMX54



**FOOT SOLDIER™**

DMX55



**LEO™**

DMX55



**TIGER CLAW™**

DMX55

VISIT | VISITE | VISITA | VISITA | VAI SU | AUF | WIĘCEJ | GA NAAR | ПОСЕТИТЕ ВЕБСАЙТ  
**TMNT.MEGABLOKS.COM**

FOR MORE TURTLES ACTION! | POUR ENCORE PLUS D'ACTION TORTUES NINJA!  
 PARA MÁS ACCIÓN DE TORTUGAS NINJA! | PARA MAIS AÇÃO COM AS TARTARUGAS NINJA!  
 E SCOPRI TUTTA L'AZIONE DEI NINJA TURTLES! | FINDET MAN NOCH MEHR TURTLES-ACTION!  
 PRZYGDÓ Z ŻÓŁWIAMI NA | VOOR MEER NINJA TURTLES ACTIE! | ЧТО МОЖНО НАЙТИ  
 ДРУГИЕ ИГРЫ С ЧЕРЕПАШКАМИ!



©2016, MEGA Brands Inc. ® & ™ MEGA Brands Inc. Printed in Canada. D-DMX55-02

Each sold separately and subject to availability. / Tous vendus séparément. Certains produits peuvent ne pas être commercialisés. / Se venden por separado y están sujetos a disponibilidad. / Vendidos em separado e sujeitos à disponibilidade. / Ognuno in vendita separatamente secondo disponibilità. / Alle Artikel separat erhältlich. Einige Artikel werden nicht in allen Ländern vertrieben. / Sprzedawane oddzielnie w zależności od dostępności. / Per stuk verkrijgbaar en niet overal leverbaar. / Каждый продукт продается отдельно, в зависимости от наличия. / Sælges separat og så længe lager haves. / Alla delar säljs separat så långt lagret räcker. / Hver leke selges separat så langt lageret rekker. / Jokainen myydään erikseen, saatavuus voi vaihdella. / Το καθένα πωλείται ξεχωριστά και ανάλογα με τη διαθεσιμότητα.

تباع كل منها على حدة وتخضع لتوافرها. 每件单独出售，并且视库存情况而定。 それぞれ在庫状況に従って個別に販売されます。