

nickelodeon™
TEENAGE MUTANT NINJA
TURTLES



Donnie™

Turtle Racer | Bolide Tortue Ninja
Vehículo de carreras de Tortuga Ninja
Carro de Corrida Tartaruga | Turtle Racer
Turtle-Rennwagen | Żółwia Wyścigówka
Turtle Racer | Гоночный автомобиль "Черепашка"

1x
AM74401APG

1x
AM74400APG

2x
AM17062APG

2x
AM19392APG

4x
MA17003APG

2x
AM74397F

1x
AM74648F

1x
AM76060APG

2x
M07223X

2x
AM19999F

1x
AM18623F

2x
MA0910APG

2x
MA15258APG

4x
MA07629F

2x
MA07629APG

2x
AM76959F

1x
AM75956APG

4x
MA1140DH

1x
AM18220F

1x
MA03484F

1x
AM17835APG

3x
MA09393APG

2x
AM18546APG

1x
MA09013APG

2x
MA18671F

3x
MA18223APG

2x
MA15484APG

6x
AM16972F

1x
MA03485F

1x
MA03773F

1x
AM16967APG

2x
AM73454AMC

2x
AM17788KF

4x
AM17788APG

1x
AM72233APG

1x
AM72264APG

2x
AM02783F

1x
MA03772APG

2x
M03772KF

2x
MA09493F

1x
MA09493APG

1x
AM17408APG

3x
MA17521F

1x
MA1087F

1x
AS-DMX52-01

1x
AS-DMX52-02

1x
AM76819DH

1x
AM03548DH

1x
AM03549DH

1x
AM77046DH

1x
AM77045DH

1x
AM75954APG

1x
AM74821W

2x
MA09292DH

1x
AM17394F

2x
MA1480F

1x
AM76819DH

1x
AM03548DH

1x
AM03549DH

1x
AS-DMX52-05

1x
AS-DMX52-06

1x
AS-DMX52-07

1x
AS-DMX52-08

1x
AS-DMX52-09

1x
AS-DMX52-10

1x
AS-DMX52-11

1x
AS-DMX52-12

1x
AS-DMX52-13

1x
AS-DMX52-14

1x
AS-DMX52-15

1x
AS-DMX52-16

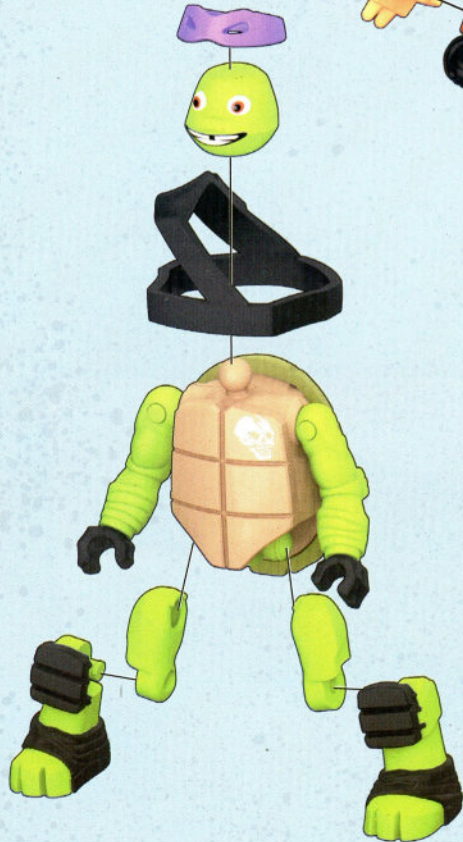
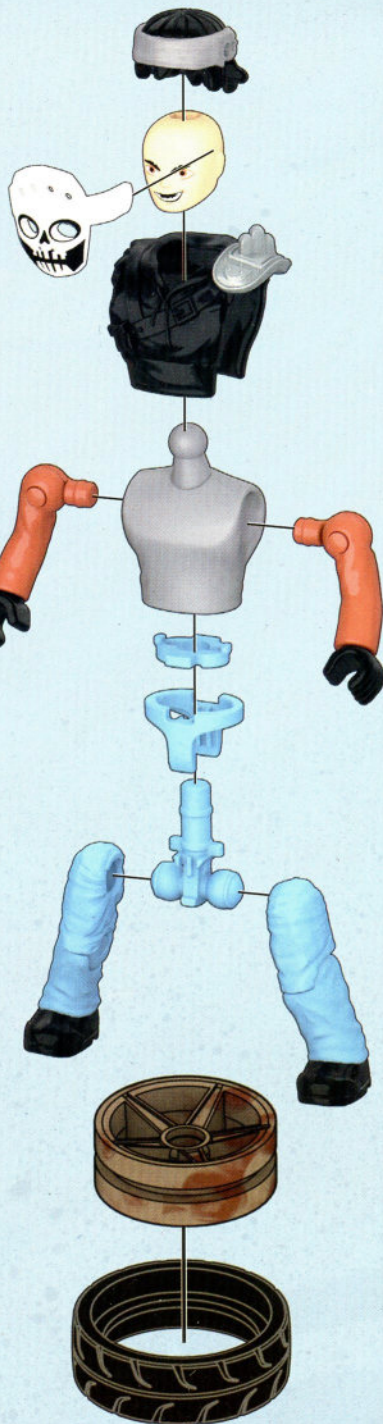

1x
FIG-DMX52-A



1x
FIG-DMX52-B

- ⚠ WARNING:
CHOKING HAZARD. - Small parts.
Not for children under 3 years.
- ⚠ ATTENTION:
DANGER D'ÉTOUFFEMENT. - Présence de petits éléments.
Ne convient pas aux enfants de moins de 3 ans.
- ⚠ تحذير:
خطر الاختناق - قطع صغيرة.
غير صالحة للأطفال أقل من 3 سنوات.
- ⚠ 警告:
窒息危险。包含有小部件
不适合3岁以下的小孩玩。
- ⚠ 警告:
のどにつまる危険 小さな部品が含まれています
3歳以下の子供には与えないで下さい。

- ADVERTENCIA: Peligro de asfixia. Juguete no recomendado para menores de 3 años, porque contiene piezas pequeñas que podrían provocar asfixia en casode ser ingeridas o inhaladas por el/la niño/a.
- ATENÇÃO: Não recomendável para crianças com menos de 36 meses. Contém peças pequenas capazes de criar risco de asfixia.
- ATTENZIONE: Contiene pezzi di piccole dimensioni.
- ACHTUNG: Kleine Teile.
- OSTRZEŻENIE: Małe części
- WAARSCHUWING: Kleine onderdelen
- ПРЕДУПРЕЖДЕНИЕ: Мелкие детали
- ADVARSSEL: Små dele.
- VARNING: Smådelar
- ADVARSSEL: Små deler.
- VAROITUS: Pieniä osia
- ΠΡΟΣΟΧΗ: Περιλαμβάνονται μικρά κομμάτια.



Please read these instructions carefully before first use and keep them for future reference.
Il est recommandé de lire attentivement ce feuillet avant la première utilisation et de le conserver pour référence future.
Leer estas instrucciones cuidadosamente antes de la primera utilización y guardarlas para referencia futura.
Leia as instruções antes do primeiro uso e guarde-as para futura referência.
Leggere le istruzioni prima di cominciare ad usare il gioco e conservarle per reference future.
Die Gebrauchsanleitung bitte durchlesen und aufbewahren.
Proszę uważnie przeczytać instrukcję obsługi przed pierwszym użyciem, a następnie zachować ją na przyszłość.
Wij raden u aan deze handleiding zorgvuldig te lezen en te bewaren voor eventuele raadpleging op een later tijdstip.
Внимательно прочитайте инструкцию перед первым использованием и сохраните ее для дальнейшего использования.
Vær venlig at læse disse instruktioner omhyggeligt inden ibrugtagen og opbevar dem til fremtidigt brug.
Läs noggrant igenom dessa instruktioner innan du använder produkten för första gången och spara dem för ev. framtida frågor.
Les disse instruksjonene nøye før første gangs bruk, og ta vare på dem for fremtidige oppslag.
Lue nämä ohjeet huolellisesti ennen ensimmäistä käyttöä ja säilytä ne myöhempää tarvetta varten.
Διαβάστε αυτές τις οδηγίες προσεκτικά πριν χρησιμοποιήσετε το προϊόν για πρώτη φορά και φυλάξτε τις για μελλοντική αναφορά.
يرجى قراءة هذه التعليمات بدقة قبل البدء بالاستعمال والاحتفاظ بها كمرجع للمستقل
请在初次使用前仔细阅读这些指示，并保留它们以便未来参考。
初めてご使用になる前に、この説明書をよくお読みください。また、本書は将来いつでも参照できるように保管してください。



U.S Patent N° D714,887
TMNT.MEGABLOKS.COM



1

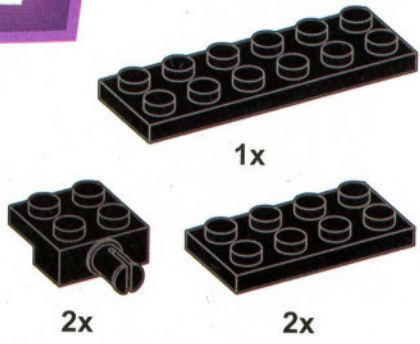

2

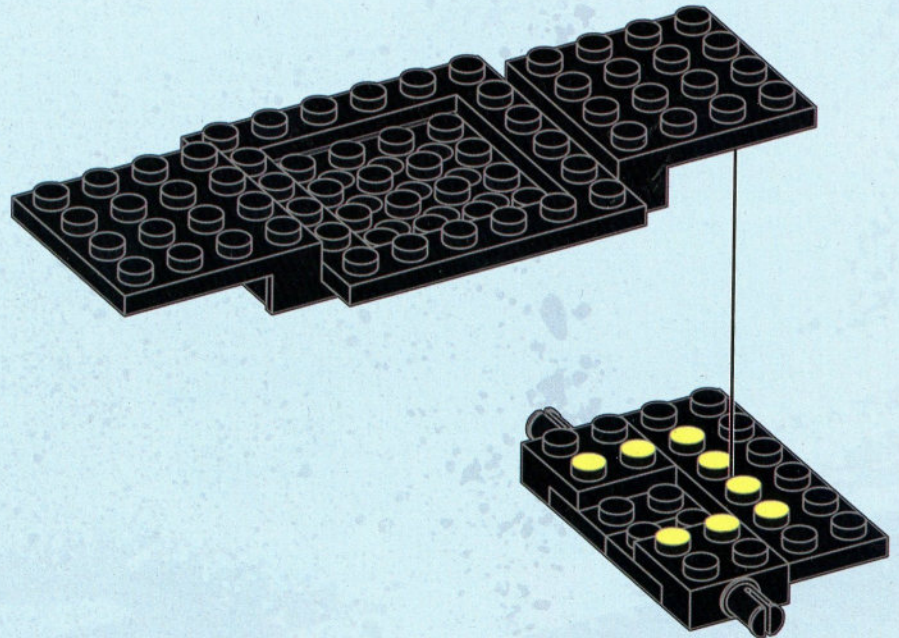
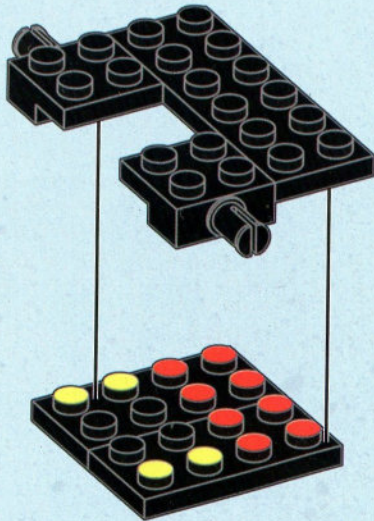
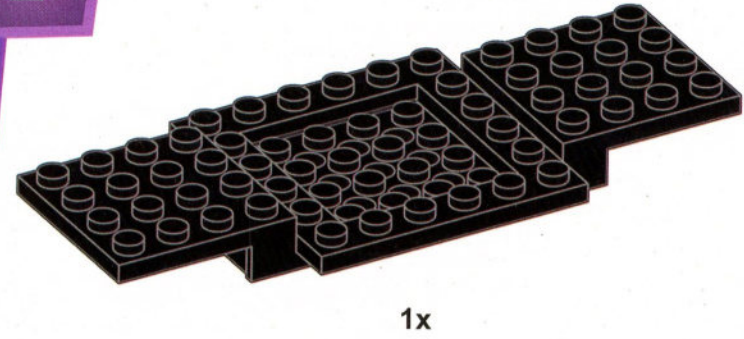

3



2x



4x



2x

4



1x



1x

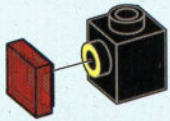

1



2

x2

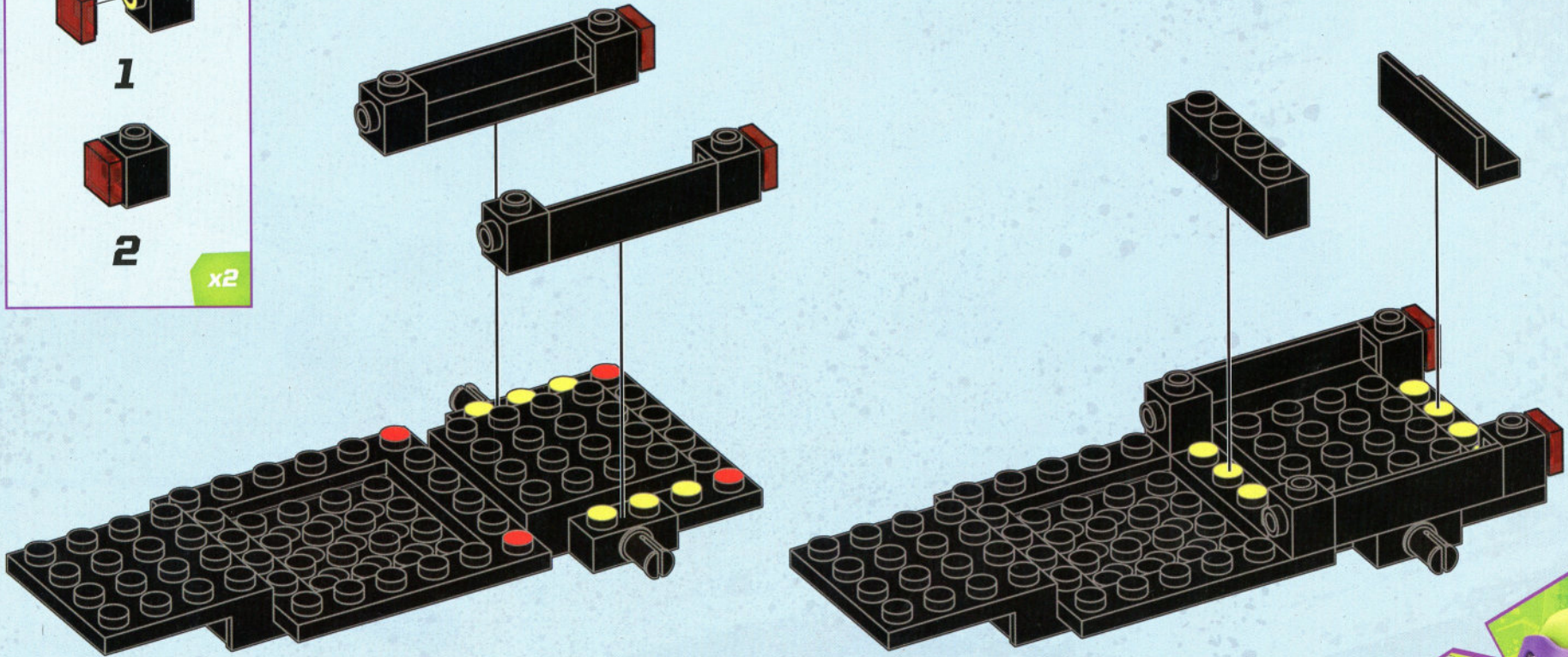

5

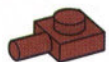

4x

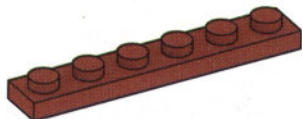

2x

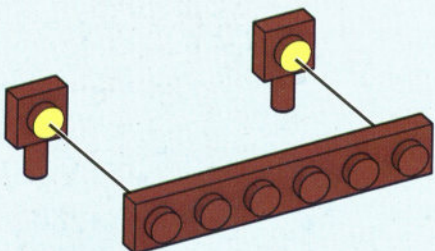

x2

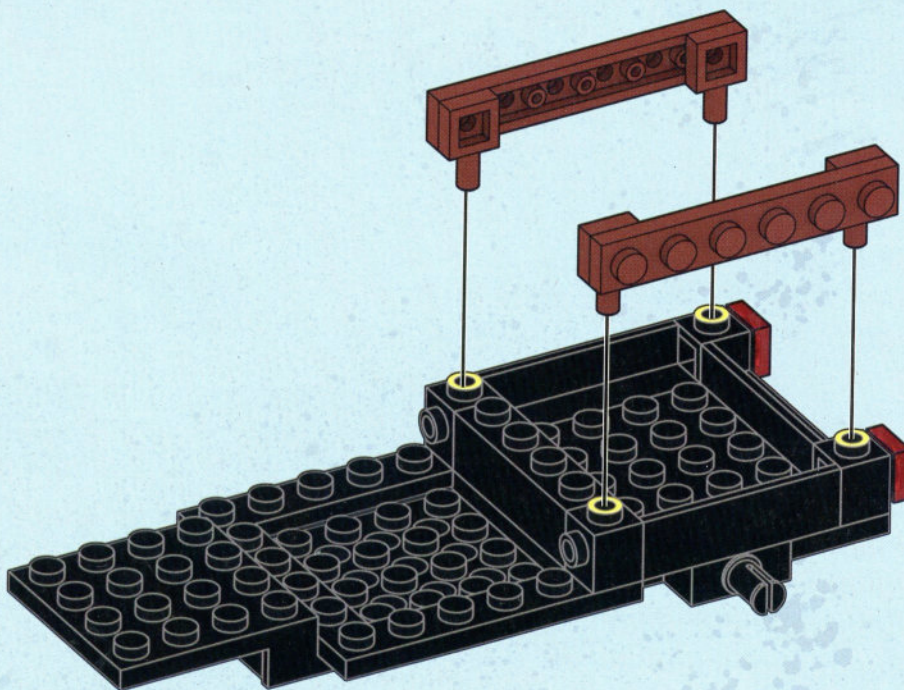

6



6x

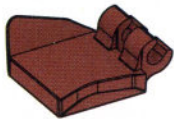

1x



1x



x2

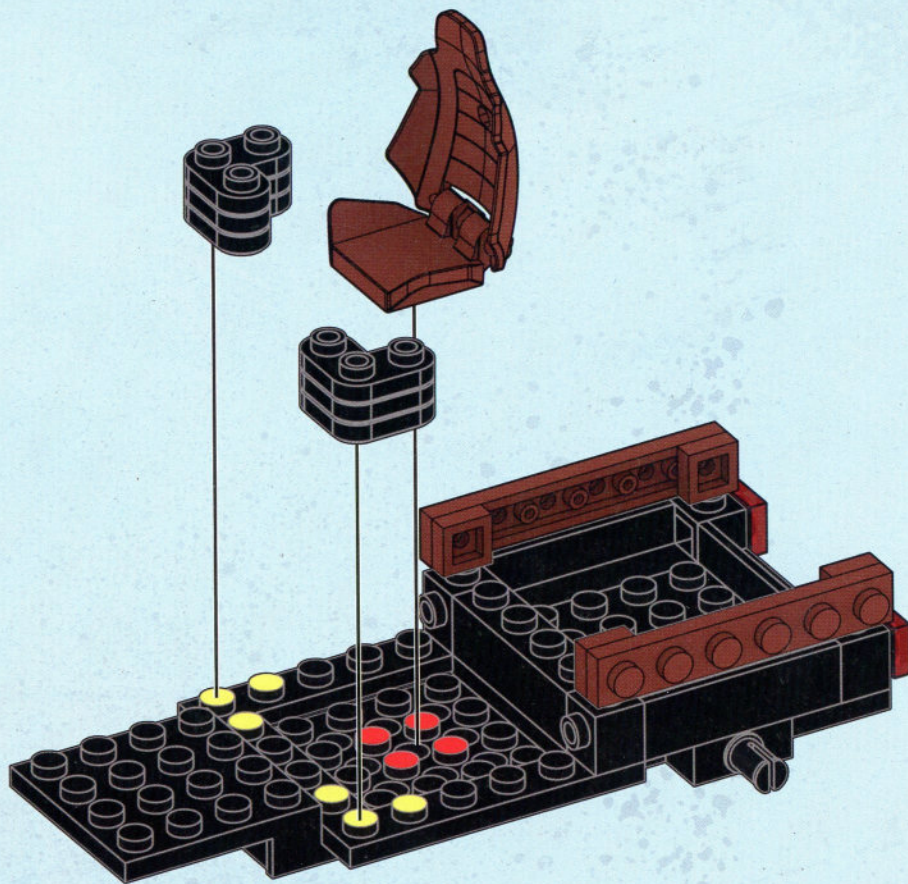
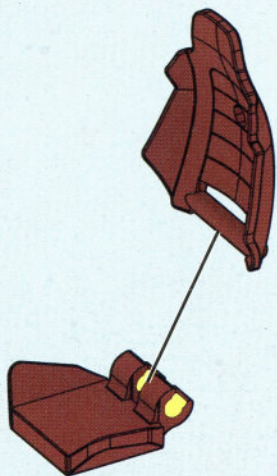

7



2x



2x



1x



1x



2x



1x



1x

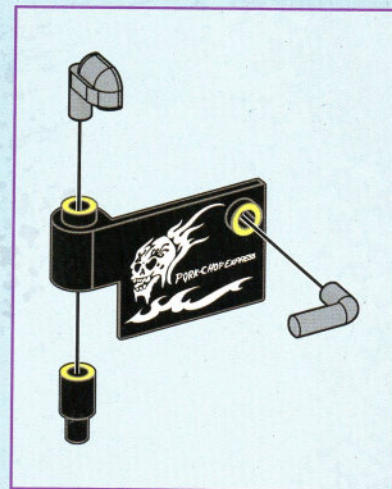
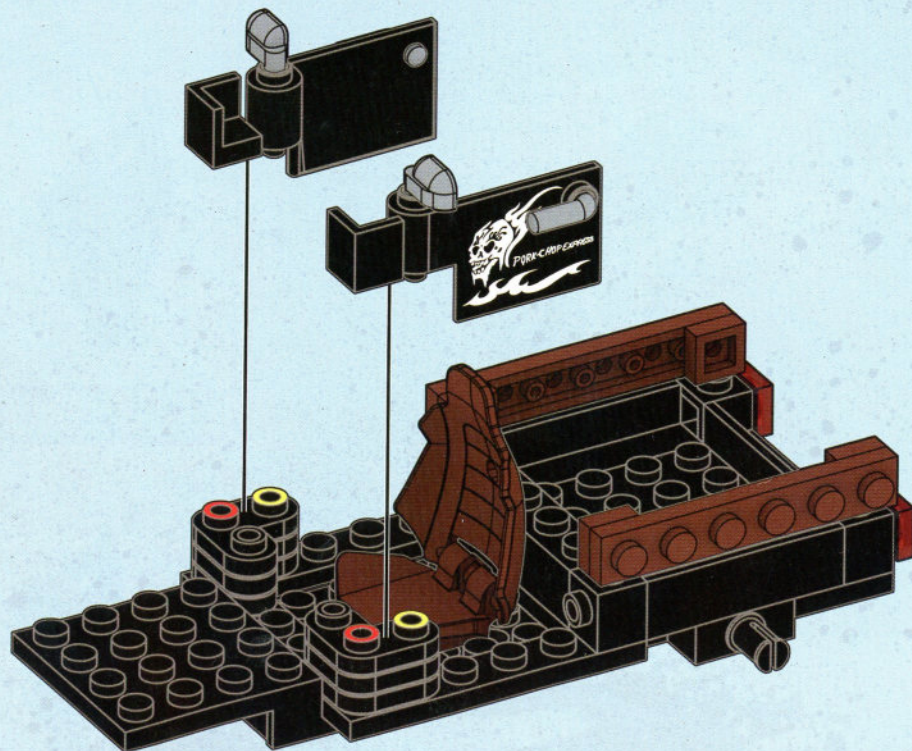
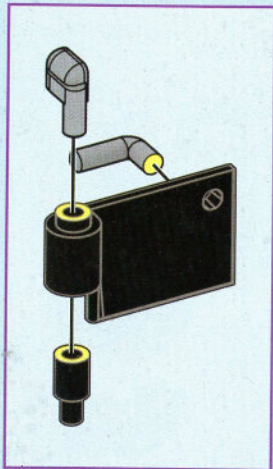

8



1x



1x



2x



1x

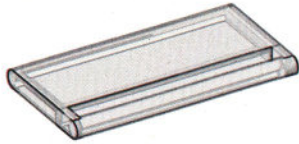

1x

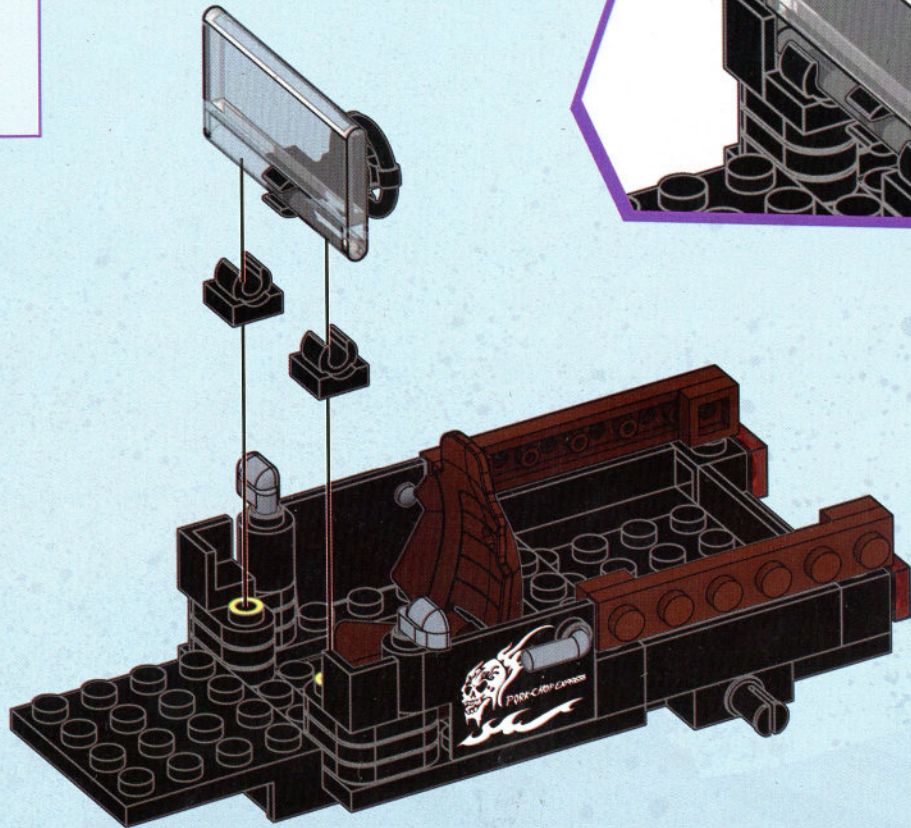
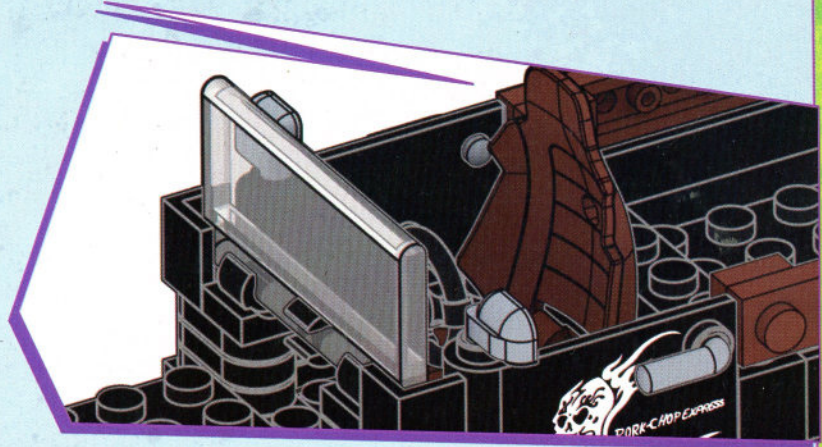
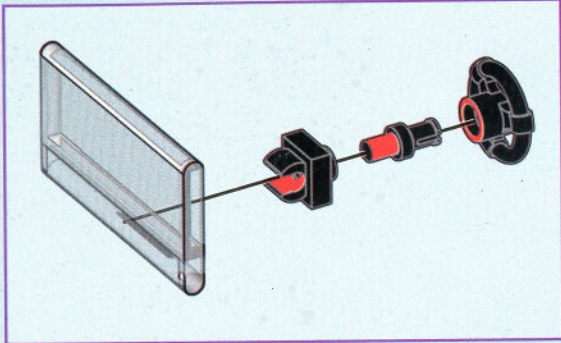

9

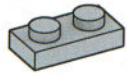

2x



1x

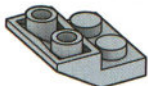

3x



2x

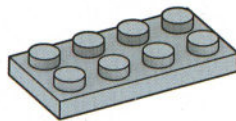

1x

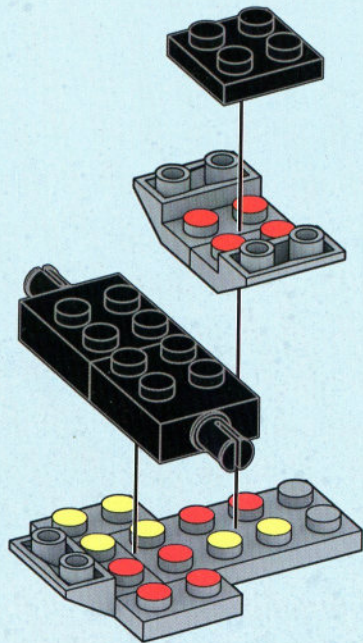

1

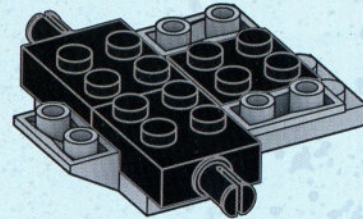

2

10

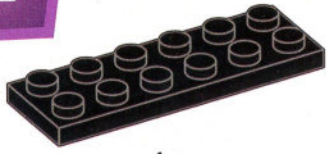

1x

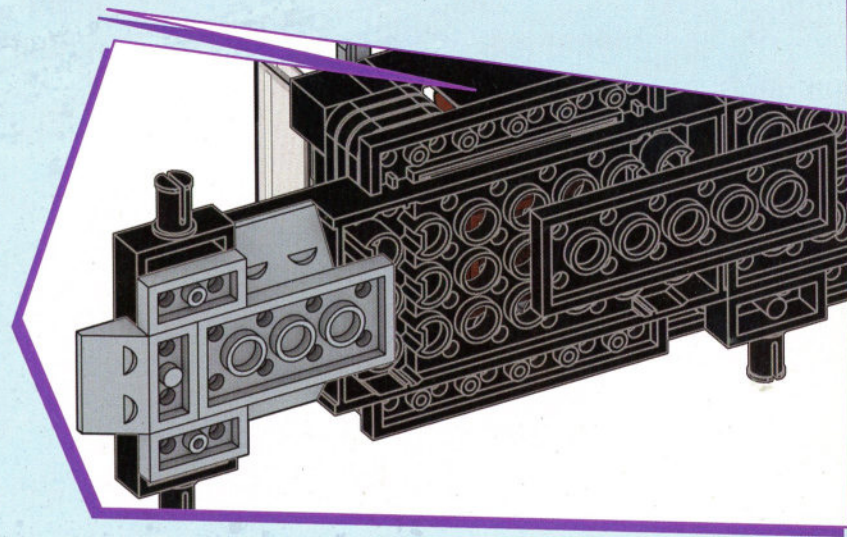
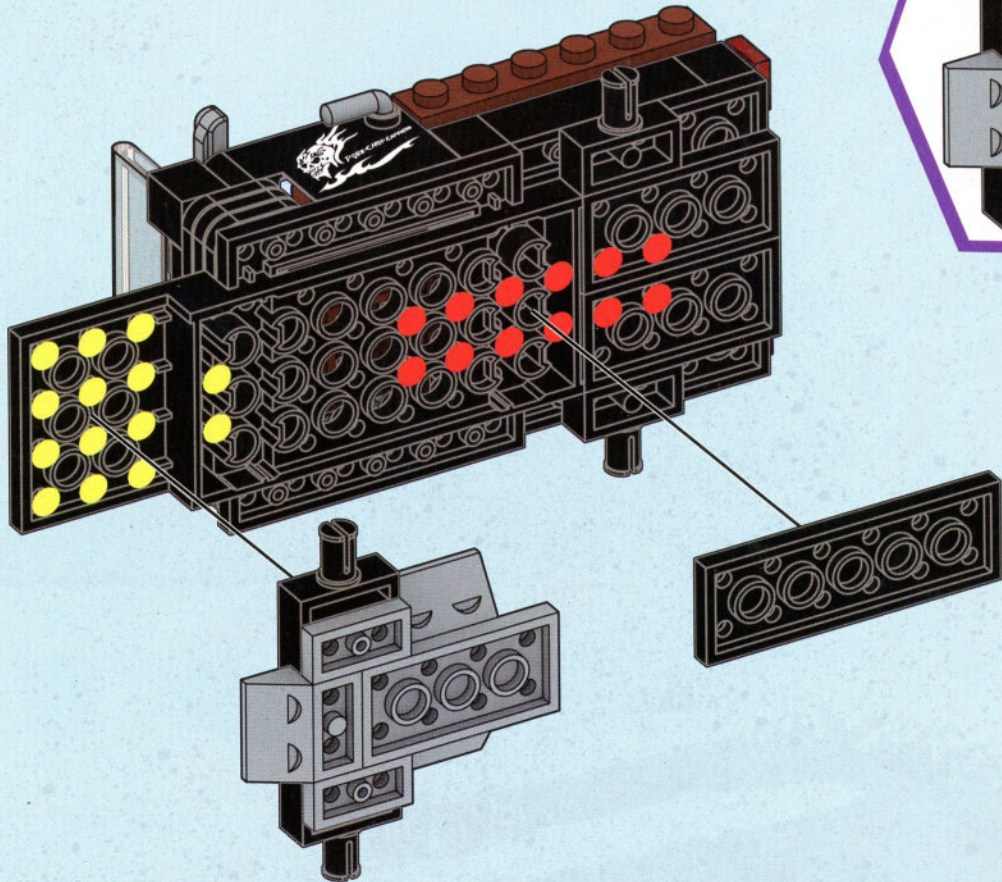

11



2x



2x



2x

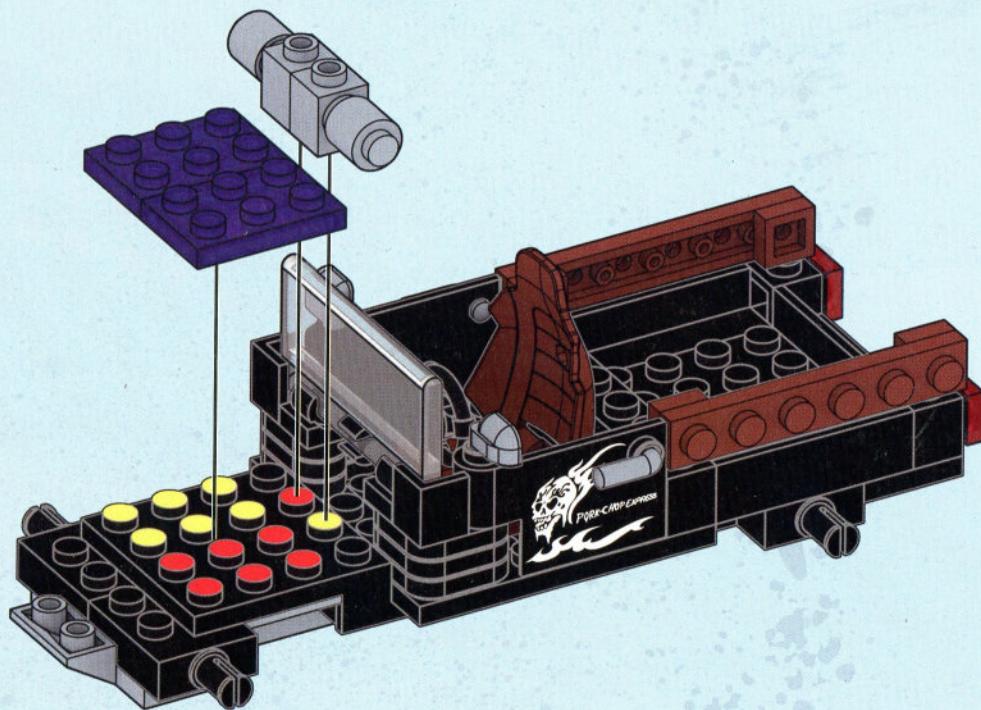
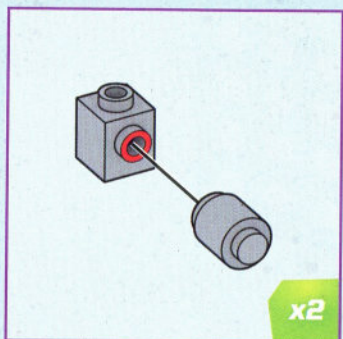

12

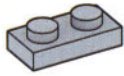

1x

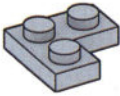

2x

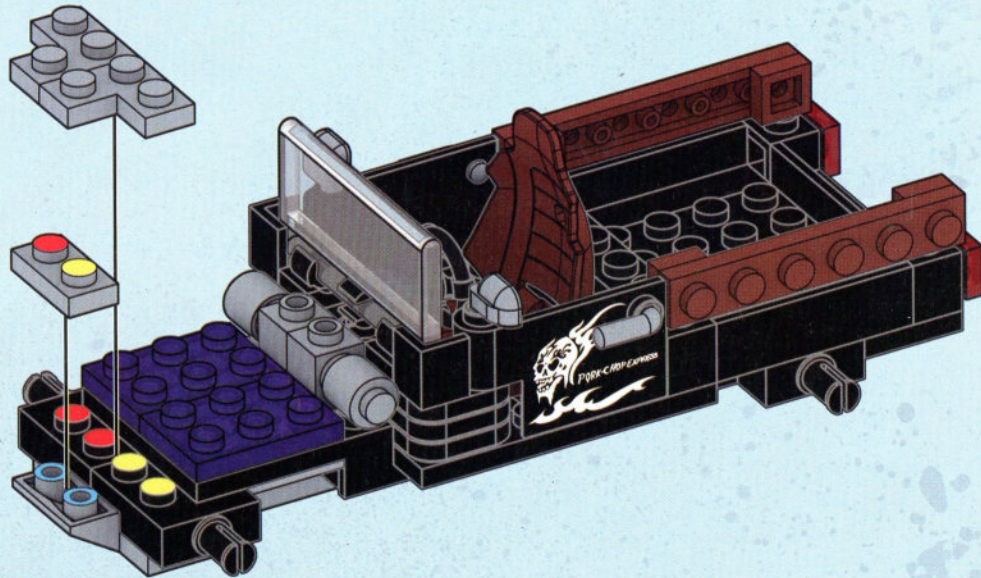

13



1x

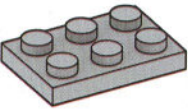

1x

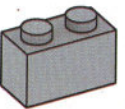

1x

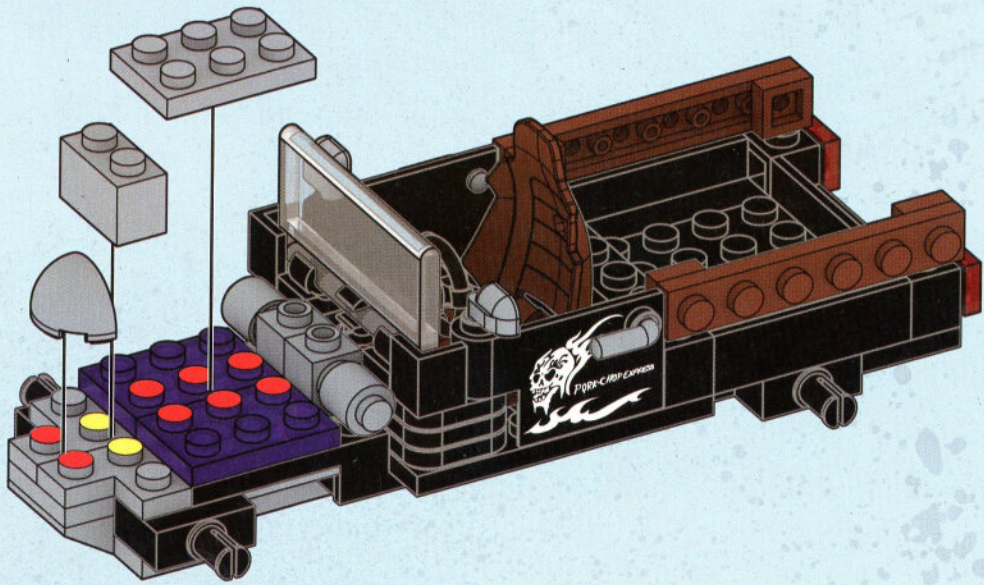

14



2x

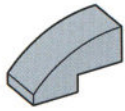

4x



2x

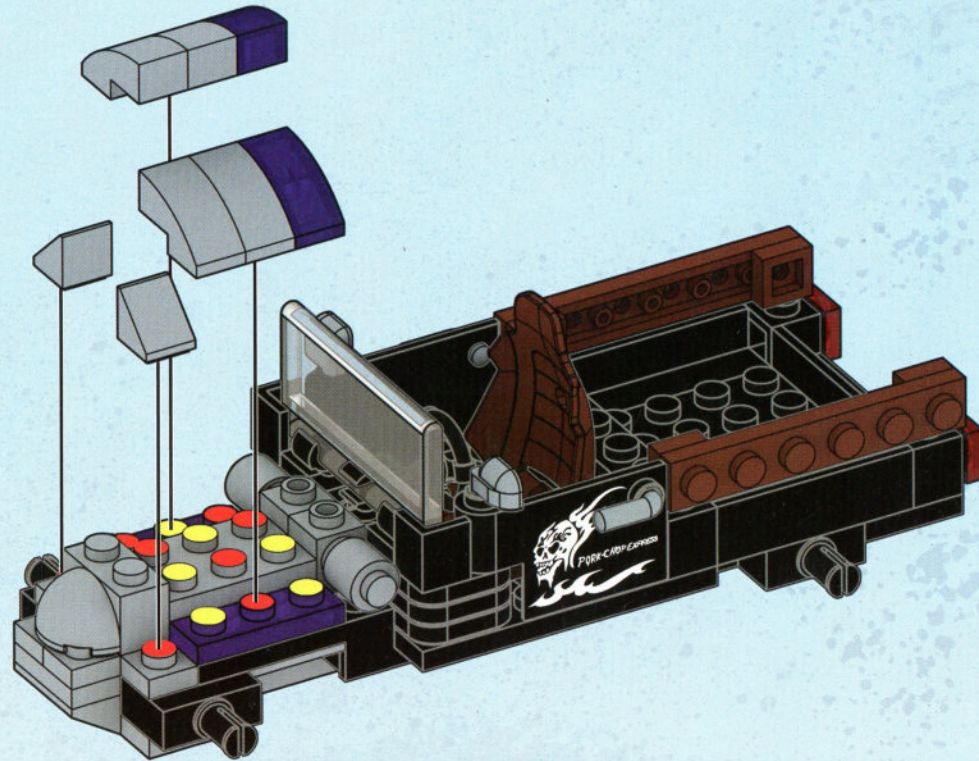

15



2x



1x



2x

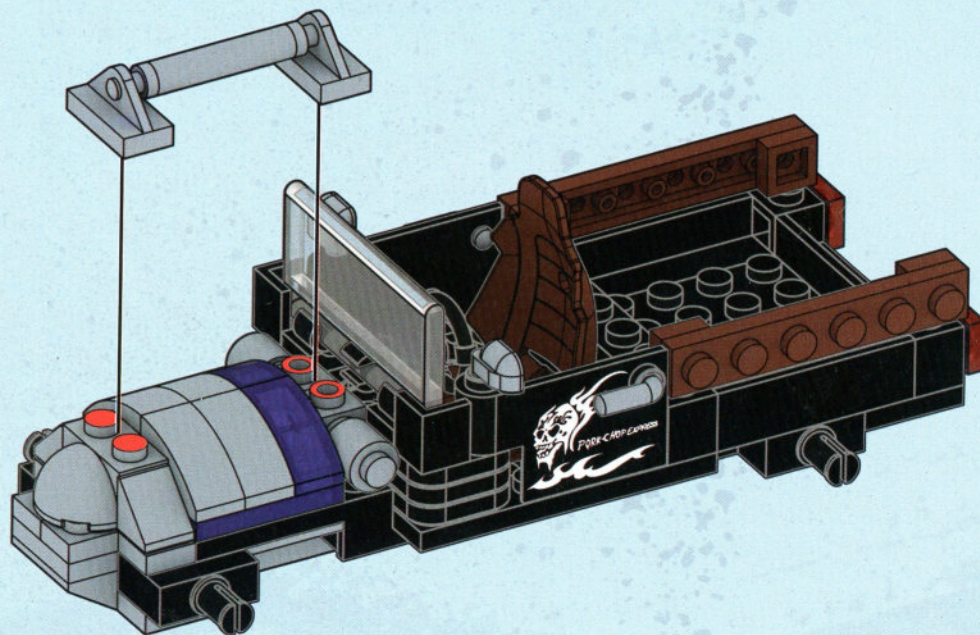
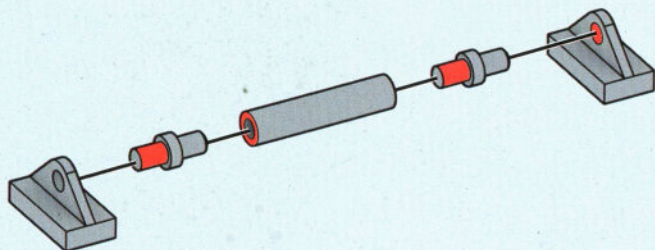

16



1x



1x

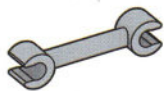

1x

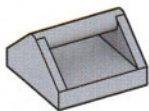

1x

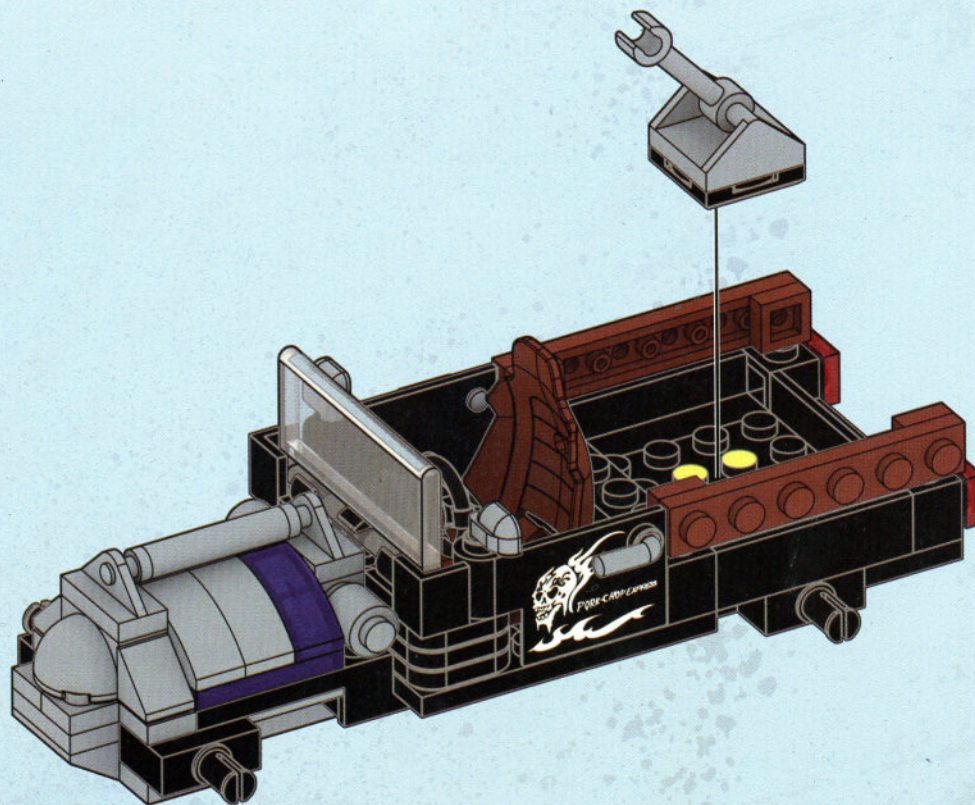
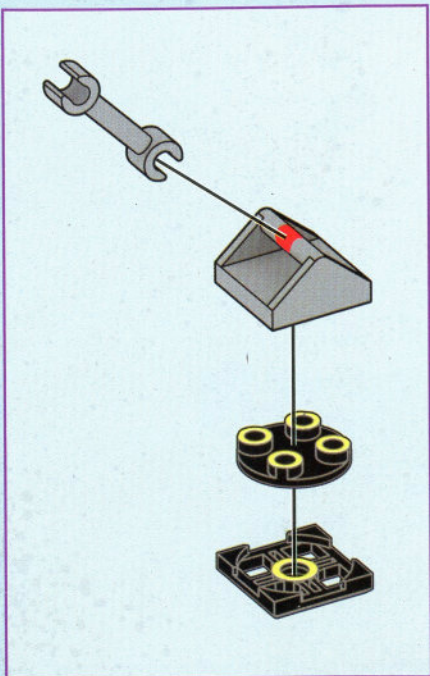

17



1x



2x



1x



1x



2x

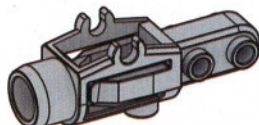

1x

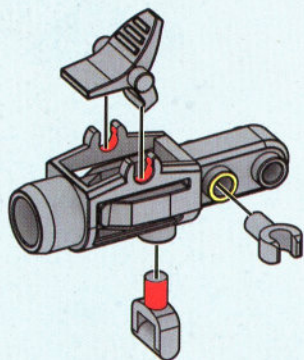

1

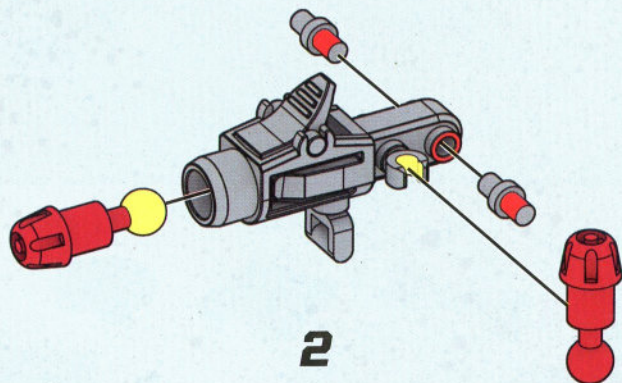

2

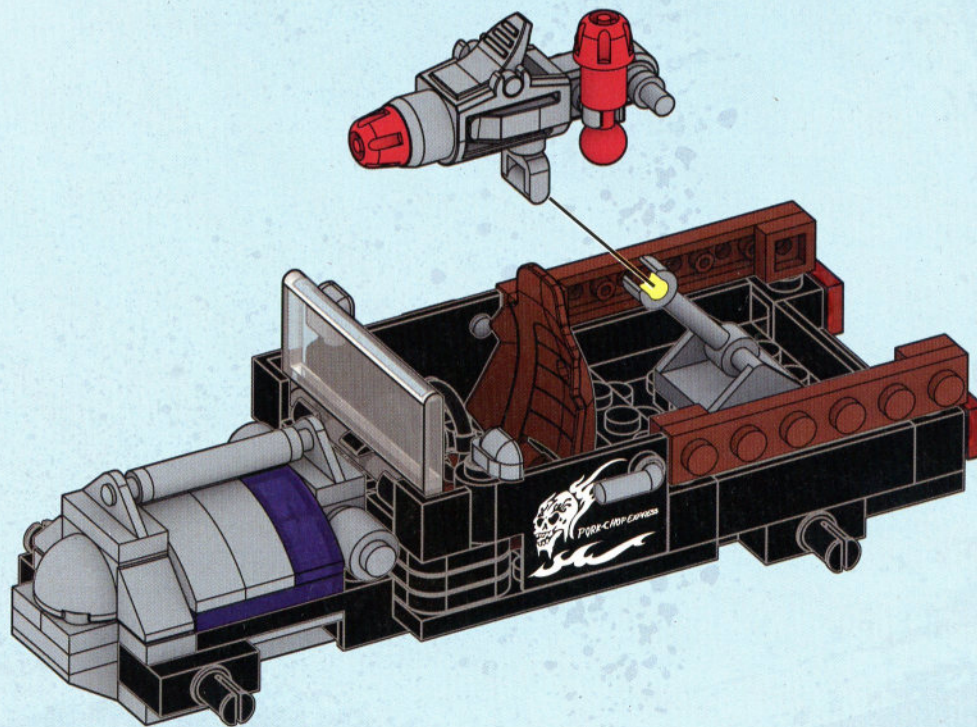

18



1x



1x



1x



1x

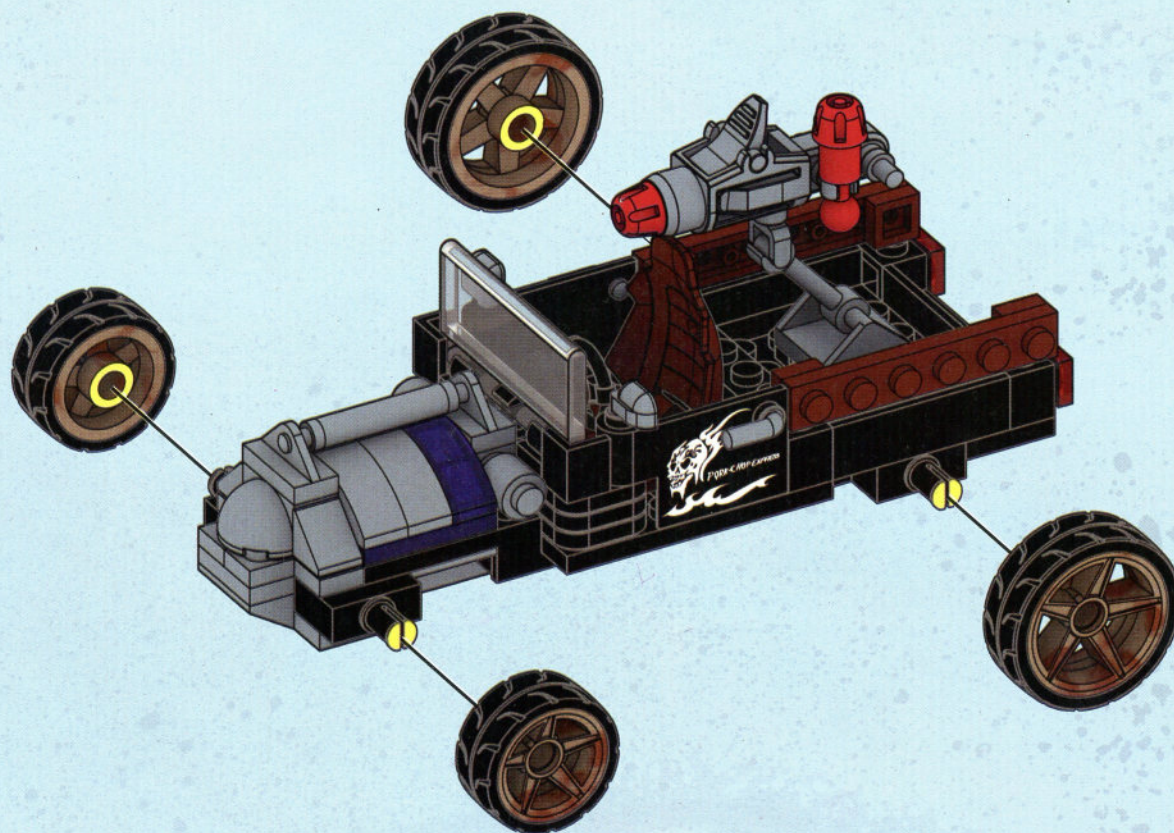

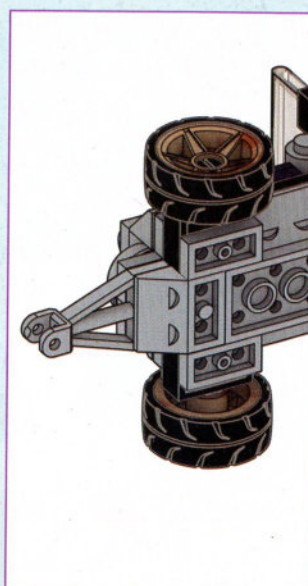
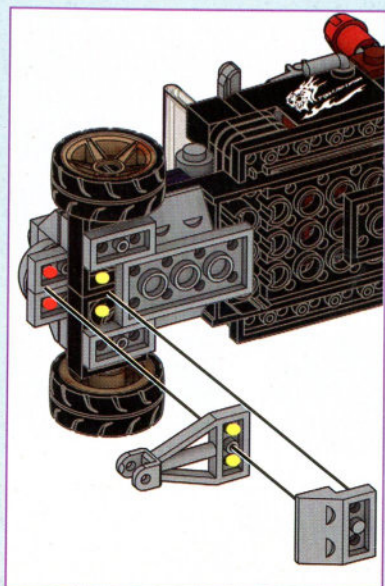
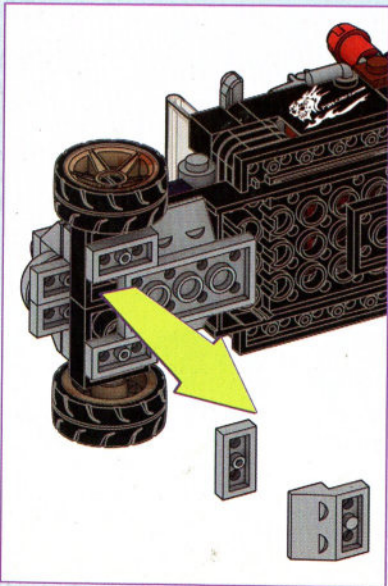
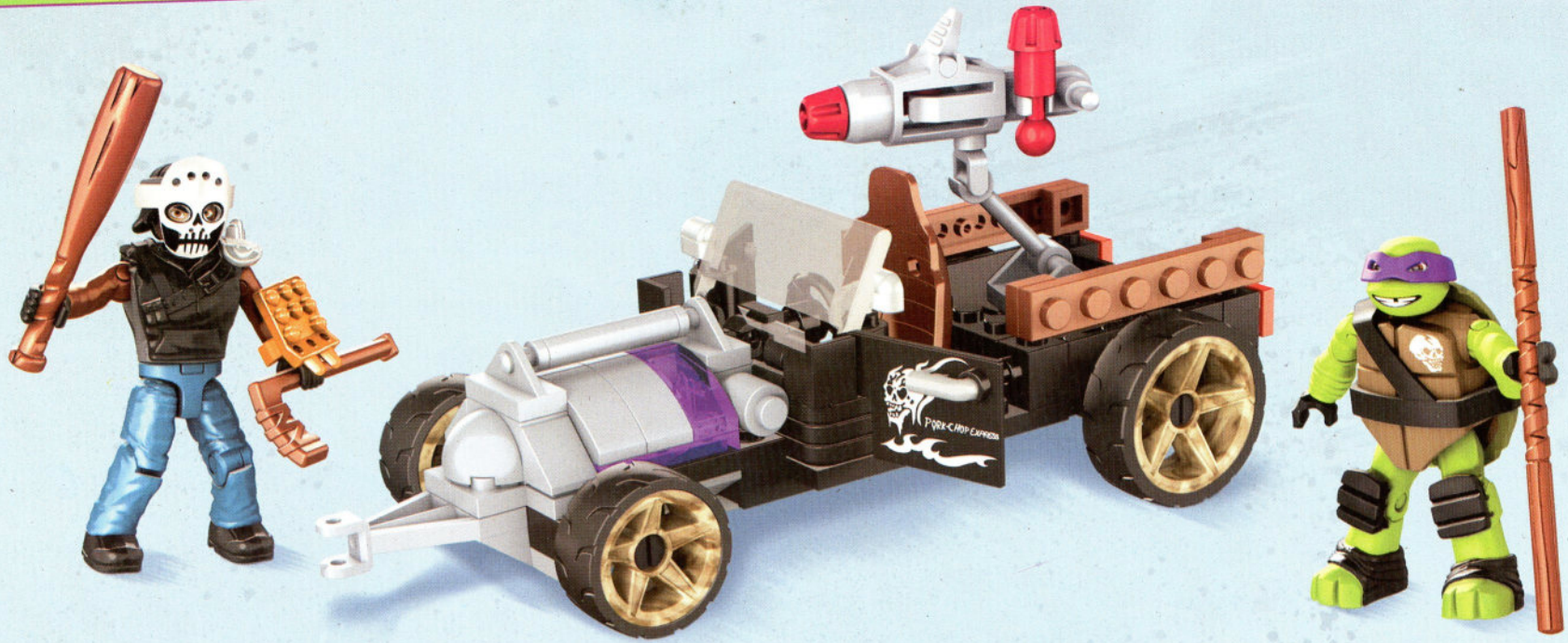

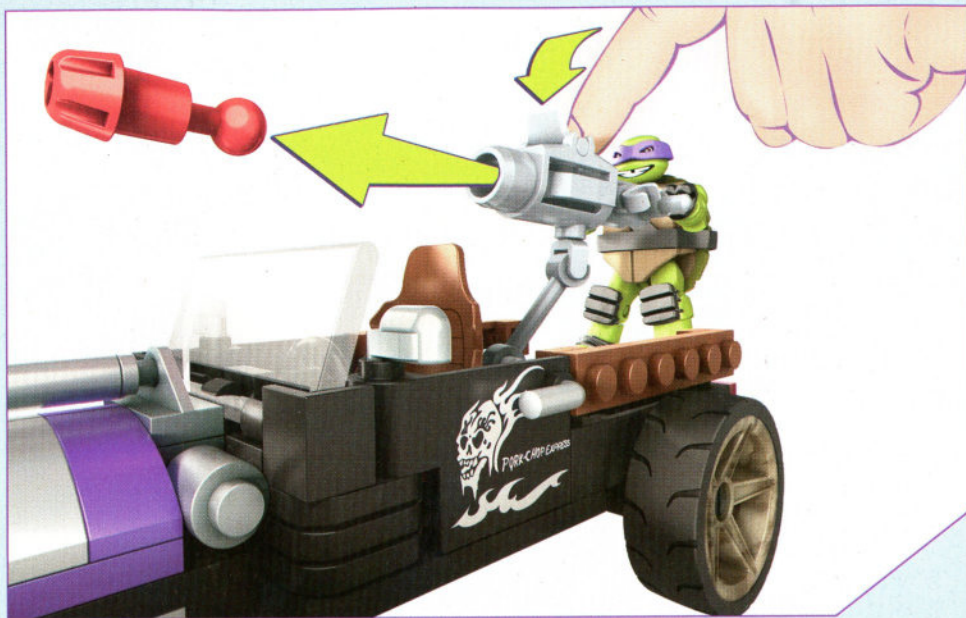

Warning: Do not aim at eyes or face. Only use projectiles supplied with this toy. Do not fire at point blank range.

Attention : Ne pas viser les yeux ou le visage. Ne pas utiliser d'autres projectiles que ceux fournis avec ce jouet. Ne pas tirer à bout portant. Advertència: No apuntar hacia los ojos o la cara. Utilizar exclusivamente los proyectiles suministrados con este juguete. No disparar a quemarropa.

Atenção! Não apontar para os olhos e para a face. Não utilizar projéteis diferentes dos providos. Não disparar excessivamente perto do alvo.

Attenzione: Non puntare agli occhi o al viso. Usa solo i proiettili forniti con il giocattolo. Non sparare a distanza ravvicinata.

Achtung: Nicht auf Augen oder Gesicht zielen. Nur die zu diesem Spielzeug gehörenden Projektile verwenden. Nicht auf Menschen oder Tiere oder aus nächster Nähe zielen.

Ostrzeżenie: Nie celuj w oczy ani w twarz. Używaj wyłącznie rzutek BOOMco.™. Nie strzelaj z bliska.

Waarschuwing: niet op ogen of gezicht richten. Gebruik uitsluitend de bijgeleverde projectielen. Niet van te dichtbij afschieten.

Предупреждение: Не направляйте в глаза или лицо. Используйте только детали, входящие в комплект. Не стреляйте со слишком близкого расстояния.

Advarsel: Sigt ikke mod øjne eller ansigt. Brug kun de projektiler, som følger med legetøjet. Skyd ikke direkte på personer eller ting.

Varning! Sikta inte mot ögon eller ansikte. Använd endast projektiler som medföljer leksaken. Fyra inte av på mycket nära håll.

Advarsel: Du må ikke sikte mot øyne eller ansikt. Bruk bare prosjektilene som følger med leken. Ikke skyt på noe på kloss hold.

Varoitus: Älä tähtää silmiin eikä kasvoihin. Käytä ainoastaan tämän tuotteen mukana tulleita ammuksia. Älä ammu lähietäisyydeltä.

Προσοχή: Μην στοχεύετε στα μάτια ή στο πρόσωπο. Χρησιμοποιείτε μόνο τα βλήματα που περιλαμβάνονται. Μην στοχεύετε προς ανθρώπους ή ζώα.

تحذير: يجب عدم التصويب باتجاه العينين أو الوجه. يجب استخدام المقذوفات المزودة مع هذه اللعبة فقط. يجب عدم الإطلاق من مدى قريب.

警告: 请勿对着眼睛或脸部发射。仅使用本玩具自带的抛射物。请勿近距离射击。

警告: 目や顔を狙わないでください。このおもちゃに同梱されている発射物のみ使用するようしてください。到達可能な距離内で火を燃やさないでください。

DMX54 and Foot soldier™ - Each sold separately and subject to availability. / Tous vendus séparément. Certains produits peuvent ne pas être commercialisés. / Se venden por separado y están sujetos a disponibilidad. / Vendidos em separado e sujeitos à disponibilidade. / Ognuno in vendita separatamente secondo disponibilità. / Alle Artikel separat erhältlich. Einige Artikel werden nicht in allen Ländern vertrieben. / Sprzedawane oddzielnie w zależności od dostępności. / Per stuk verkrijgbaar en niet overal leverbaar. / Каждый продукт продается отдельно, в зависимости от наличия. / Sælges separat og så længe lager haves. / Alla delar säljs separat så långt lagret räcker. / Hver leke selges separat så langt lageret rekker. / Jokainen myydään erikseen, saatavuus voi vaihdella. / Το καθένα πωλείται ξεχωριστά και ανάλογα με τη διαθεσιμότητα. /

تباع كل منها على حدة وتخضع لتوفرها. 每件单独出售，并且视库存情况而定。 それぞれ在庫状況に従って個別に販売されます。

TURTLE POWER | PODER DE TORTUGA NINJA
PODER DAS TARTARUGAS NINJA | МОЦ ŻÓŁWI
СИЛА ЧЕРЕПАШЕК

ZIPLINE ACTION! | ACTION SUR FILIN!
¡ACCIÓN DE CUERDA DE ESCAPE!
ANDA DE SLIDE! | AZIONE ECCLATANTE!
SEIL-ACTION! | TYROLKA!
ZIPLIJNACTIE! | СКОРОСТНОЙ СПУСК!

DOUBLE SLASHING ACTION!
ACTION DOUBLE FRAPPE!
¡ACCIÓN DE DOBLE ATAQUE!
DUPLO ATAQUE!
DOPPIA AZIONE DEVASTANTE!
DOPPELTE SCHLAG-ACTION!
PODWÓJNE CIĘCIE!
DUBBELE ACTIE!
ДВОЙНЫЕ УДАРЫ!

SLASHING ACTION! | ACTION DE FRAPPE!
¡ACCIÓN DE ATAQUE! | MOVIMENTOS DE BRAÇOS!
AZIONE DEVASTANTE! | SCHLAG-ACTION!
CIĘCIE! | WAT EEN ACTIE! | ФУНКЦИЯ УДАРОВ!

DMX52

DMX51
DMX55

DMX54

YOU CAN COLLECT THEM ALL! | À COLLECTIONNER!
 ¡COLECCIONALOS TODOS! | COLEZIONE TODOS!
 COLLEZIONALI TUTTI! | DU KANNST SIE ALLE SAMMELN!
 MOŻESZ ZEBRAĆ JE WSZYSTKIE! VERZAMEL ZE
 ALLEMAAL! | ТЫ МОЖЕШЬ СОБРАТЬ ИХ ВСЕХ!



DONNIE™

DMX21



FOOT SOLDIER™

DMX21



KRAANG™

DMX21



LEO™

DMX21



RAPH™

DMX21



MIKEY™

DMX21



SHREDDER™

DMX21



MIKEY™

DMX27



RAPH™

DMX32



LEO™

DMX34



RAPH™

DMX35



DONNIE™

DMX37



MIKEY™

DMX38



BAXTER™

DMX50



FOOT SOLDIER™

DMX50



LEO™

DMX50



MIKEY™

DMX51

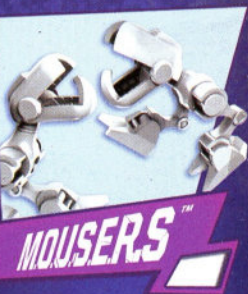

MOUSERS™

DMX51



CASEY JONES™

DMX52



DONNIE™

DMX52



RAPH™

DMX54



SHREDDER™

DMX54



FOOT SOLDIER™

DMX55



LEO™

DMX55



TIGER CLAW™

DMX55

VISIT | VISITE | VISITA | VISITA | VAI SU | AUF | WIĘCEJ | GA NAAR | ПОСЕТИТЕ ВЕБСАЙТ

TMNT.MEGABLOKS.COM

FOR MORE TURTLES ACTION! | POUR ENCORE PLUS D'ACTION TORTUES NINJA |
PARA MÁS ACCIÓN DE TORTUGAS NINJA! | PARA MAIS AÇÃO COM AS TARTARUGAS NINJA!
E SCOPRI TUTTA L'AZIONE DEI NINJA TURTLES! | FINDET MAN NOCH MEHR TURTLES-ACTION!
PRZYGDÓ Z ŻÓŁWIAMI NA | VOOR MEER NINJA TURTLES ACTIE! | ЧТО МОЖНО НАЙТИ
ДРУГИЕ ИГРЫ С ЧЕРЕПАШКАМИ!



©2016, MEGA Brands Inc. ® & ™ MEGA Brands Inc.
Printed in Canada D-DMX52-01

Each sold separately and subject to availability. / Tous vendus séparément. Certains produits peuvent ne pas être commercialisés. / Se venden por separado y están sujetos a disponibilidad. / Vendidos em separado e sujeitos à disponibilidade. / Ognuno in vendita separatamente secondo disponibilità. / Alle Artikel separat erhältlich. Einige Artikel werden nicht in allen Ländern vertrieben. / Sprzedawane oddzielnie w zależności od dostępności. / Per stuk verkrijgbaar en niet overal leverbaar. / Каждый продукт продается отдельно, в зависимости от наличия. / Sælges separat og så længe lager haves. / Alla delar säljs separat så långt lagret räcker. / Hver leke selges separat så langt lageret rekker. / Jokainen myydään erikseen, saatavuus voi vaihdella. / Το καθένα πωλείται ξεχωριστά και ανάλογα με τη διαθεσιμότητα. / 每件单独出售，并且视库存情况而定。 それぞれ在庫状況に従って個別に販売されます。

© 2016 Viacom Overseas Holdings C.V. All Rights Reserved. Teenage Mutant Ninja Turtles and all related titles, logos and characters are trademarks of Viacom Overseas Holdings C.V.