

nickelodeon™

TEENAGE MUTANT NINJA TURTLES™





ROOFTOP COMBAT
COMBAT SUR LE TOIT
COMBATE EN EL TECHO
LUTA NO TELHADO
COMBATTIMENTO SUL TETTO
DÄCHERKAMPF
POJEDYNEK NA DACHU
DAKGEVECHT
БИТВА НА КРЫШЕ

MEGA
BLOKS®

nickelodeon.

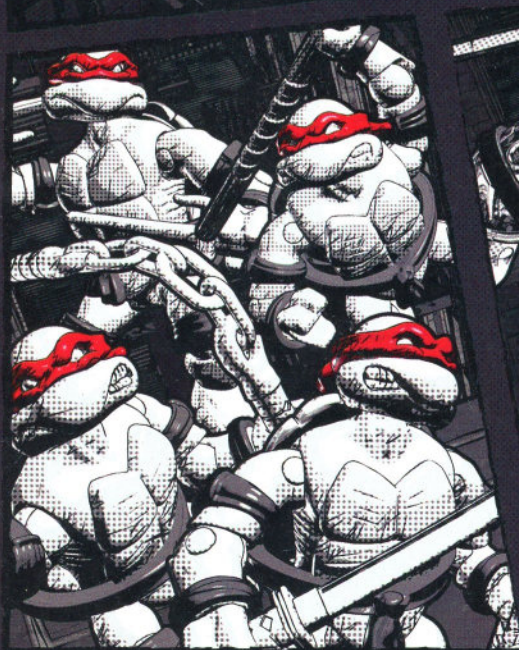
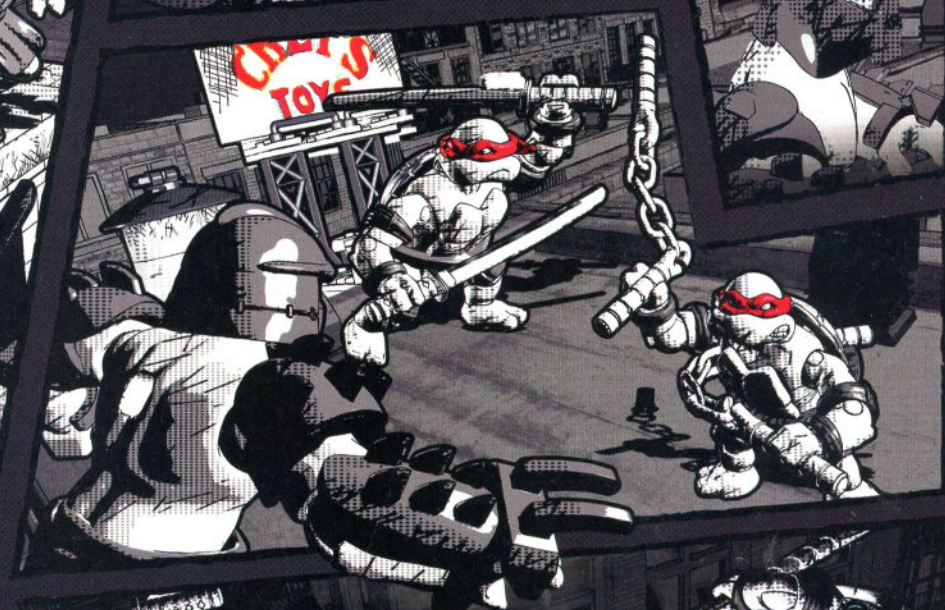
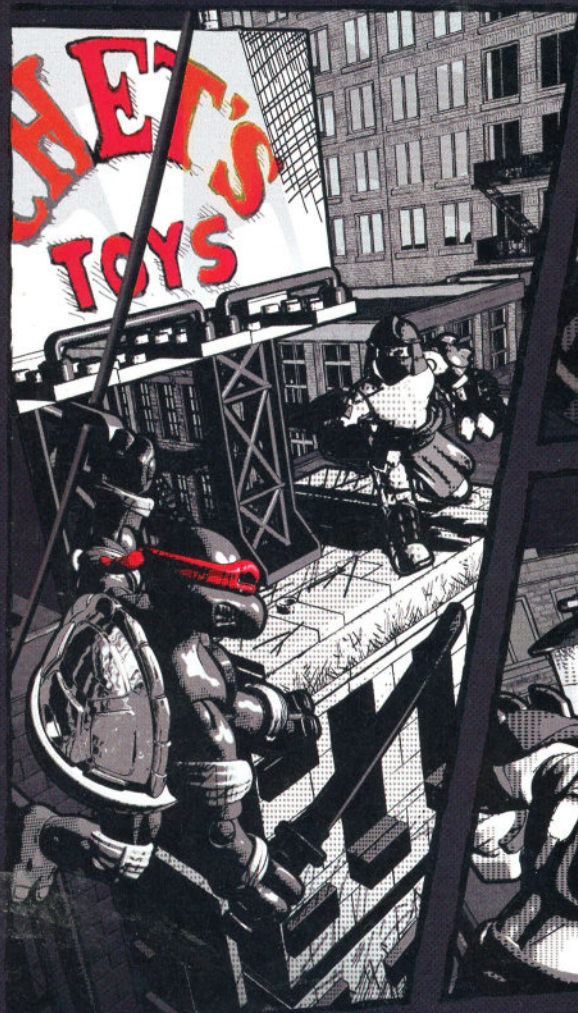
TEENAGE MUTANT NINJA TURTLES



























SUPREME ARTICULATION
ARTICULATION ULTIME
MÁXIMA ARTICULACIÓN
ARTICULAÇÃO SUPREMA
ARTICOLAZIONE SUPREMA
EXTREME BEWEGELICHKEIT
WIELE RUCHOMYCH PRZEGUBÓW
VOLLEDIG BEWEEGBAAR
ОТЛИЧНОЕ СОЕДИНЕНИЕ СУСТАВОВ

EXCLUSIVE METAL SHELL!
CARAPACE EN MÉTAL EXCLUSIVE!
¡EXCLUSIVO CARAPAZÓN DE METAL!
CARAPAÇA METALIZADA EXCLUSIVA!
UN ESCLUSIVO GUSCIO IN METALLO!
EKSKLUSYWNY METALOWY PANCERZ!
UNIEK METALEN OMHULSEL!
ЭКСКЛЮЗИВНЫЙ
МЕТАЛЛИЧЕСКИЙ ЧЕХОЛ!











METAL

-  2X AM18592AUN
-  2X MA17003AUN
-  2X AM19158AUN
-  2X AM17062AWC
-  3X AM76060AWC
-  1X AM76060E
-  1X AM18560AWC
-  7X MA1113AWC
-  3X M1113ZD
-  1X MA0910AWC
-  7X MA07223MM
-  9X MA07223AUN
-  14X MA03328AUN
-  27X MA1086AUN
-  6X MA07629AUN
-  6X AM18286AUN
-  4X AM77445AUN
-  1X AM76052AWC
-  2X MA17506AWC
-  3X AM18597MM
-  1X AM09216AWC

-  1X AM02215AWC
-  1X AM74016AWC
-  2X AM74016AUN
-  4X MA73758AUN
-  6X MA09393AUN
-  11X MA022501MM
-  10X MA022501AUN
-  1X MA18901AWC
-  5X MA17128AUN
-  2X MA1417AUN
-  1X MA16679AUN
-  2X AM18014MM
-  7X MA17502AUN
-  56X MA09013AUN
-  1X AS-DPDB0-06
-  1X MA1320MM
-  2X MA08480AUN
-  1X AM18667AUN

-  3X AM74428AUN
-  1X MA15484AUN
-  1X MA17153AUN
-  1X MA02212AUN
-  1X AM04321AUN
-  2X AM03480MM
-  1X AM03480AUN
-  4X AM03872AUN
-  6X AM03872W
-  3X MA09023AUN
-  1X AM03329AUN
-  5X MA0948AUN
-  5X MA03773AUN
-  14X MA1154AUN
-  1X AM72909AWC

-  1X AM72240AUN
-  2X AM72944AUN
-  3X MA1314AUN
-  2X MA16384AUN
-  2X MA03772AUN
-  4X MA09593AUN
-  8X MA09838AUN
-  1X AM18276MM
-  3X MA09493AUN
-  1X MA09493AWC
-  5X AM09210MM
-  1X AM74433AUN
-  1X AM74434AUN
-  1X AM15512AWC

-  1X AM72928AUN
-  3X AS-DPDB0-03
-  1X AS-DPDB0-07
-  2X AM72033MM
-  2X AM01355MM
-  2X AM17793AUN
-  2X MA09292AUN
-  4X MA16331AUN
-  1X MA1313AUN
-  1X MA04983AUN

10X
MA09922AUN

5X
MA18298AUN

1X
MA17845AUN

2X
MA74678AUN

1X
AS-DPD80-05

1X
MA172AUN

1X
MA18556AUN

1X
AM17837AWC

1X
AX-9431901

1X
AS-DPD80-02

1X
AS-DPD80-01

2X
AS-DPD79-07

2X
AM72522AUN

2X
AM73755AWC

1X
AS-DPD80-04

⚠ WARNING:
CHOKING HAZARD. - Small parts.
Not for children under 3 years.

⚠ ATTENTION:
DANGER D'ÉTOUFFEMENT. - Présence de petits éléments.
Ne convient pas aux enfants de moins de 3 ans.

⚠ تحذير:
خطر الاختناق - قطع صغيرة.
غير صالحة للأطفال أقل من 3 سنوات.

⚠ 警告:
噎住危險。包含有小部件
不适合3岁以下的小孩玩。

⚠ 警告:
のどにつまる危険 小さな部品が含まれています
3歳以下の子供には与えないで下さい。

ADVERTENCIA: Peligro de asfixia. Juguete no recomendado para menores de 3 años, porque contiene piezas pequeñas que podrían provocar asfixia en caso de ser ingeridas o inhaladas por el/la niño/a.

ATENÇÃO: Não recomendável para crianças com menos de 36 meses. Contém peças pequenas capazes de criar risco de asfixia.

ATTENZIONE: Contiene pezzi di piccole dimensioni.

ACHTUNG: Kleine Teile.

OSTRZEZENIE: Małe części

WAARSCHUWING: Kleine onderdelen

ПРЕДУПРЕЖДЕНИЕ: Мелкие детали

ADVARSEL: Små dele.

VARNING: Små delar

ADVARSEL: Små deler.

VAROITUS: Pieniä osia

ΠΡΟΣΟΧΗ: Περιλαμβάνονται μικρά κομμάτια.



0-3

U.S. Patent
No. D.714.887

Please read these instructions carefully before first use and keep them for future reference.

Il est recommandé de lire attentivement ce feuillet avant la première utilisation et de le conserver pour référence future.

Leer estas instrucciones cuidadosamente antes de la primera utilización y guardarlas para referencia futura.

Leia as instruções antes do primeiro uso e guarde-as para futura referência.

Leggere le istruzioni prima di cominciare ad usare il gioco e conservarle per reference future.

Die Gebrauchsanleitung bitte durchlesen und aufbewahren.

Proszę uważnie przeczytać instrukcję obsługi przed pierwszym użyciem, a następnie zachować ją na przyszłość.

Wij raden u aan deze handleiding zorgvuldig te lezen en te bewaren voor eventuele raadpleging op een later tijdstip.

Внимательно прочитайте инструкцию перед первым использованием и сохраните ее для дальнейшего использования.

Yer venlig at læse disse instruktioner omhyggeligt inden ibrugtagen og opbevar dem til fremtidigt brug.

Läs noggrant igenom dessa instruktioner innan du använder produkten för första gången och spara dem för ev. framtida frågor.

Les disse instruksjonene nøye før første gangs bruk, og ta vare på dem for fremtidig oppslag.

Lue nämä ohjeet huolellisesti ennen ensimmäistä käyttöä ja säilytä ne myöhempää tarvetta varten.

Διαβάστε αυτές τις οδηγίες προσεκτικά πριν χρησιμοποιήσετε το προϊόν για πρώτη φορά και φυλάξτε τις για μελλοντική αναφορά.

يرجى قراءة هذه التعليمات بدقة قبل البدء بالاستعمال والاحتفاظ بها كمرجع للمستقبل.

请在初次使用前仔细阅读这些指示，并保留它们以便未来参考。

初めてご使用になる前に、この説明書をよくお読みください。また、本書は将来いつでも参照できるように保管してください。





2X
AS-DPDB0-09



1X
FIG-DPDB0-B



1X
AS-DPDB0-08



2X
AM76821F



1X
FIG-DPDB0-A

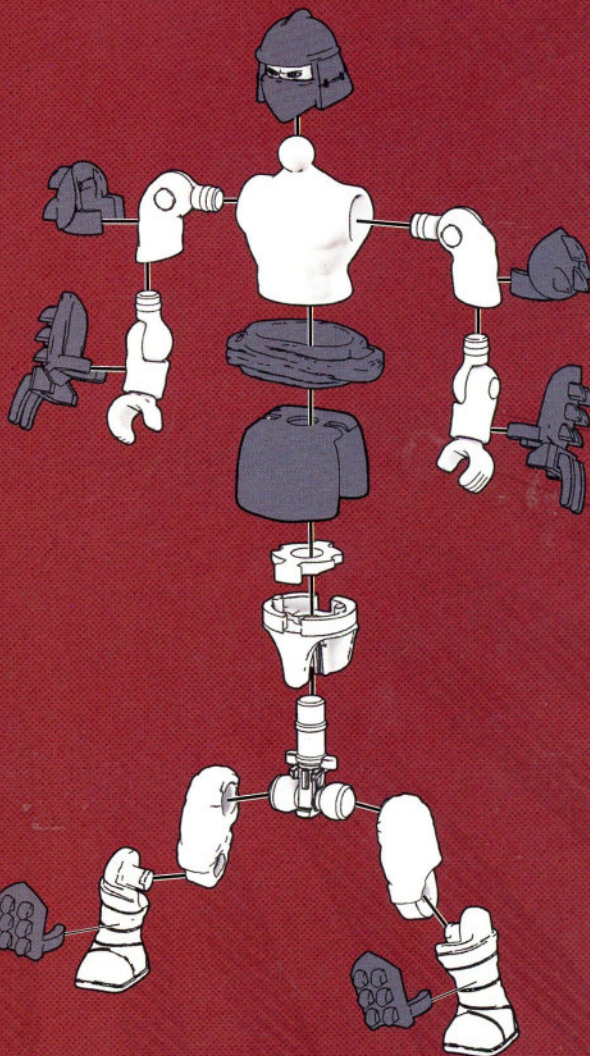
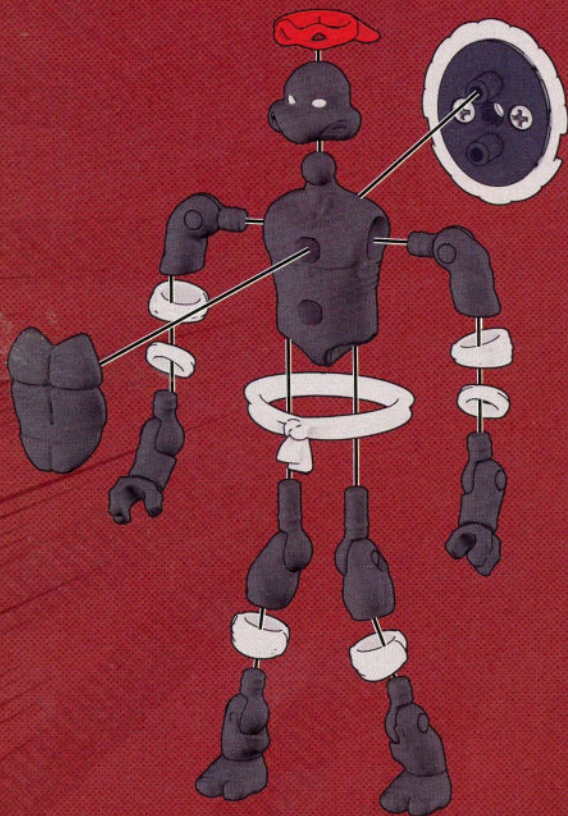

1

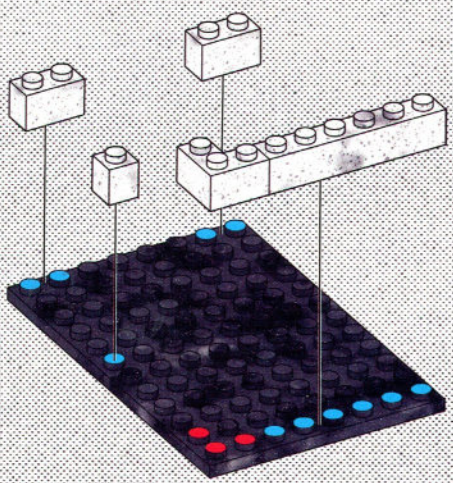
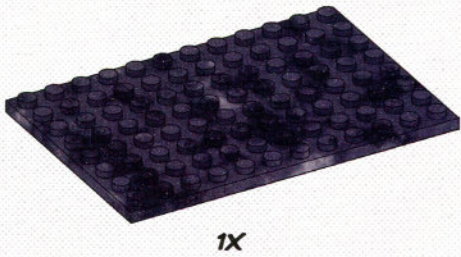
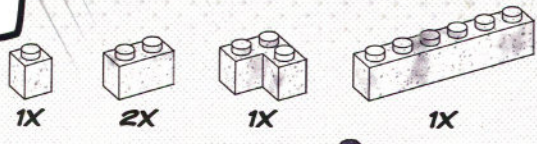

2

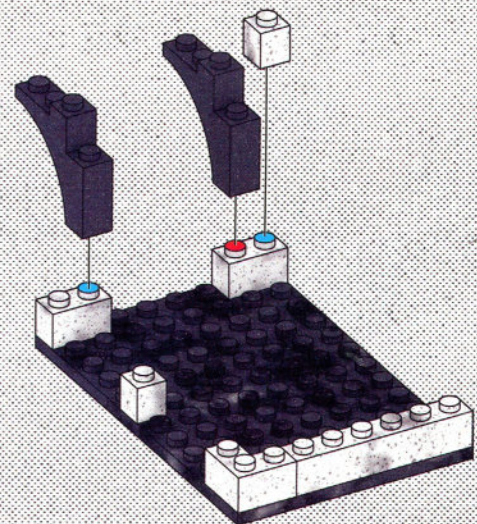
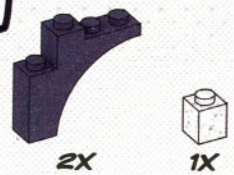

3

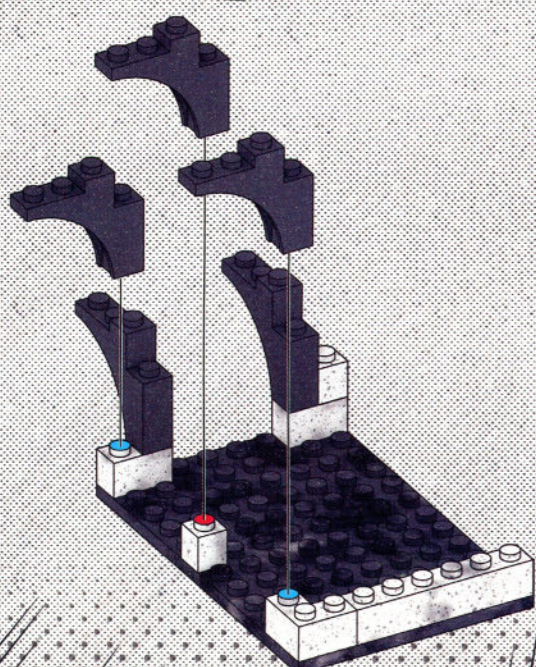
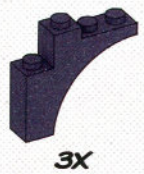

4

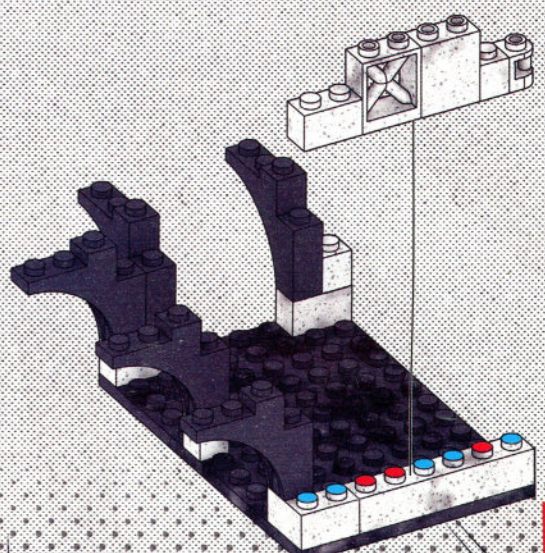
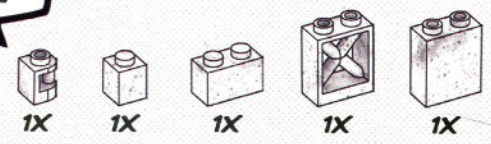

5



1X

1X

2X

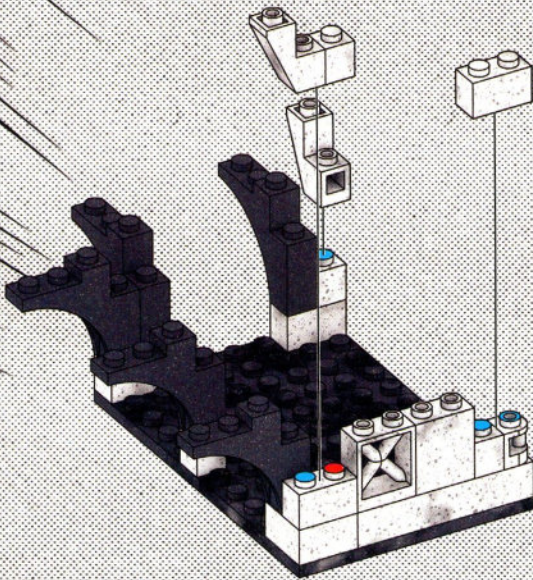

6



3X

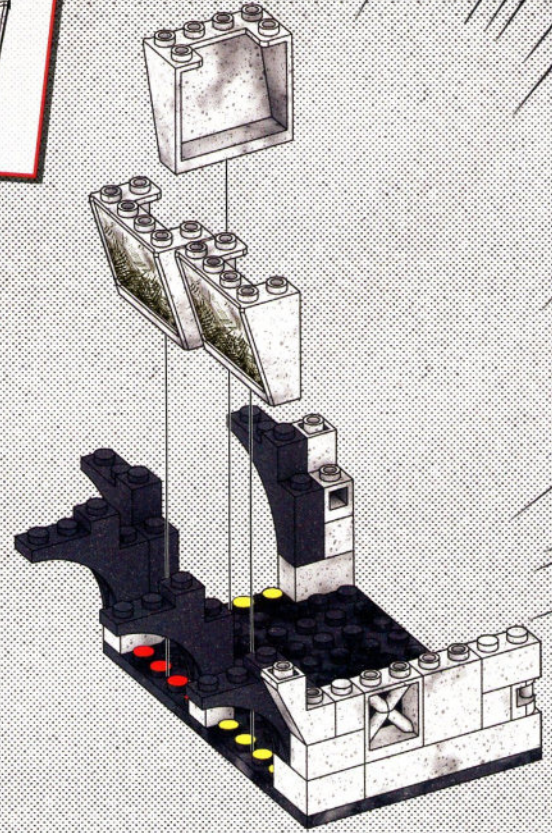

7

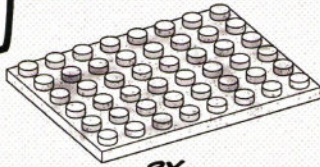

2X

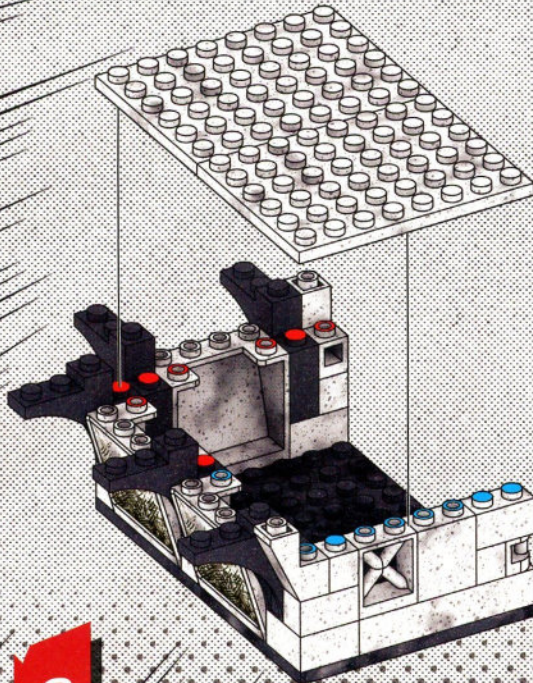

8



6X

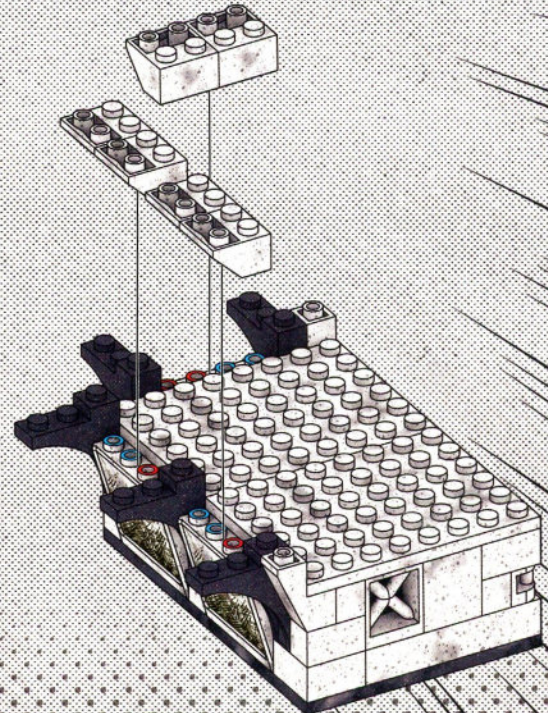

9

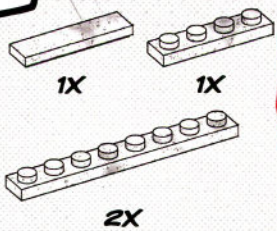

10

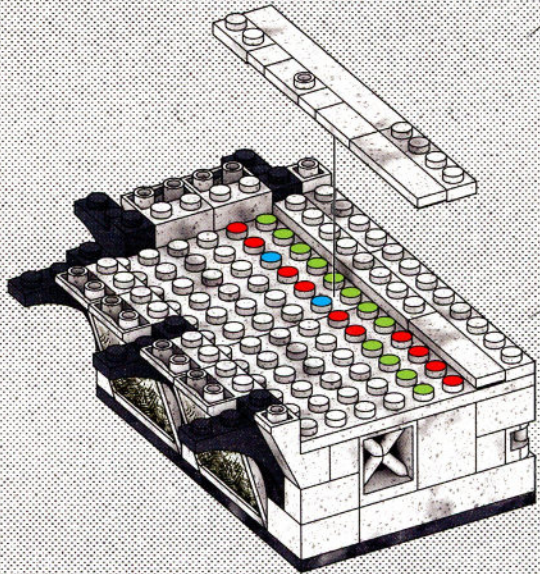
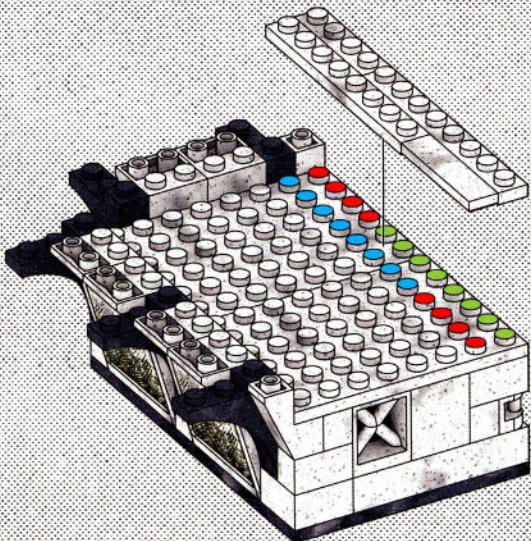
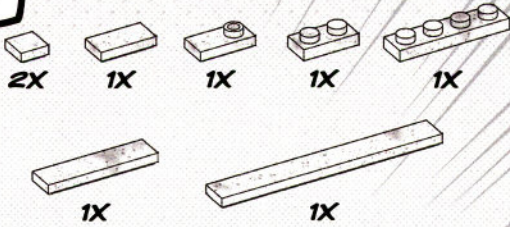

11

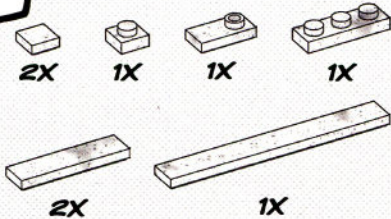

12

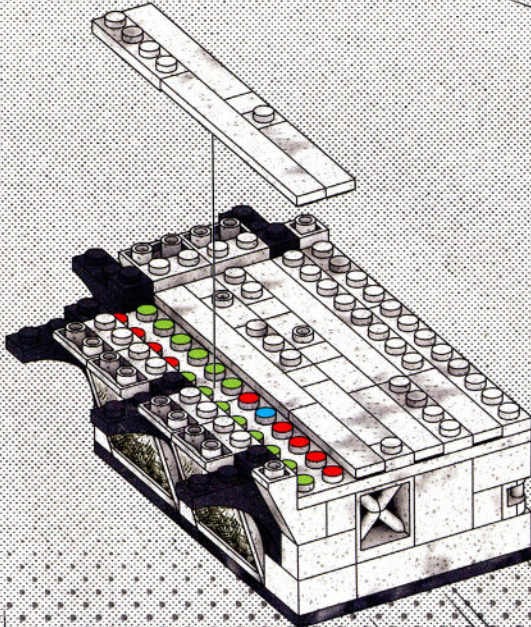
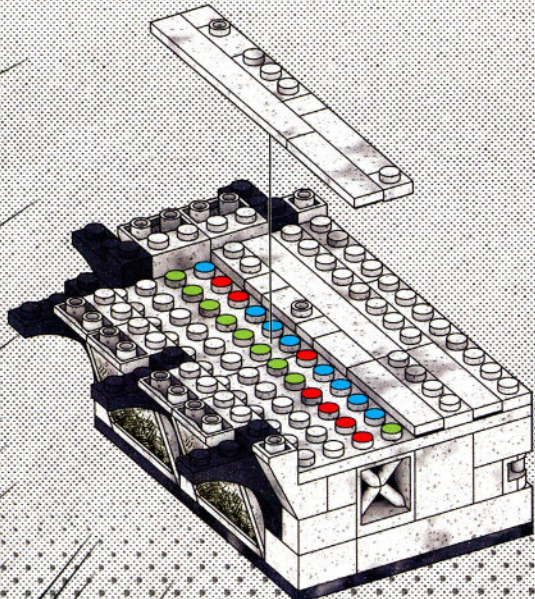
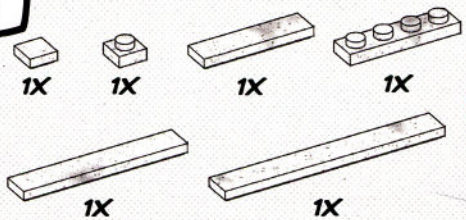

13

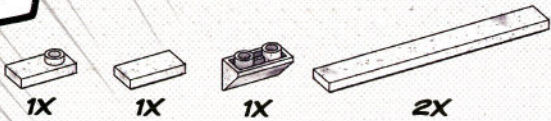

14

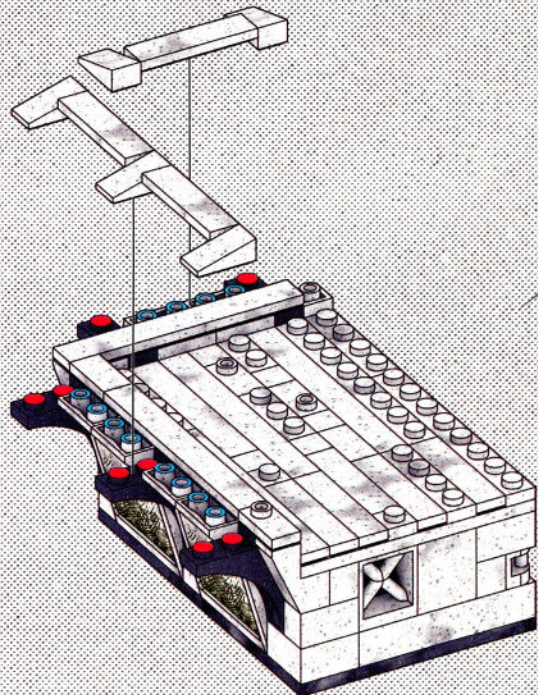
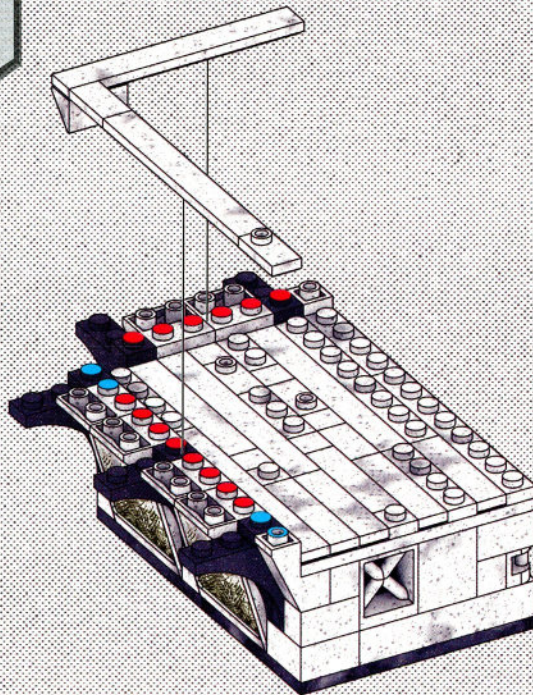
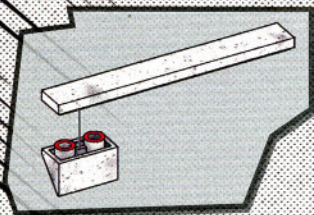
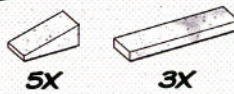

15



16

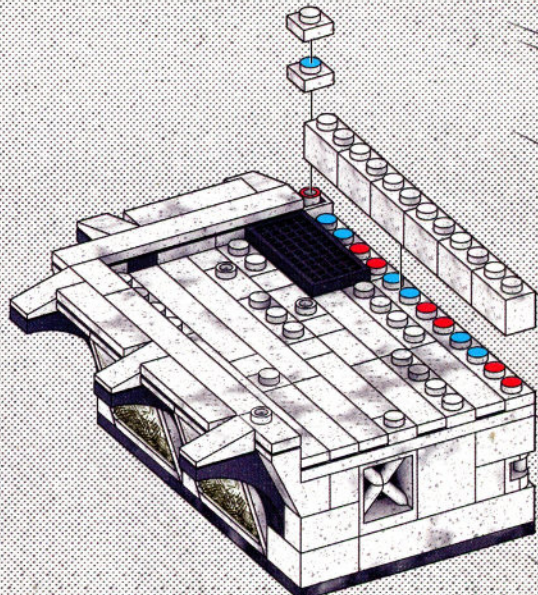
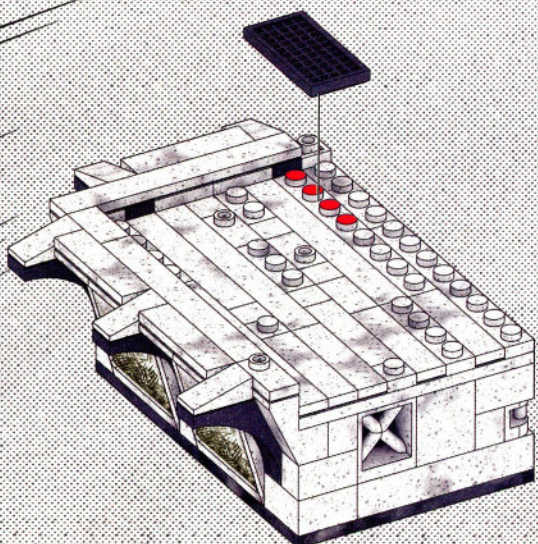
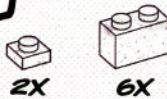

17

- 2X
- 1X
- 5X
- 1X

18

- 1X
- 1X
- 2X
- 1X
- 4X
- 1X

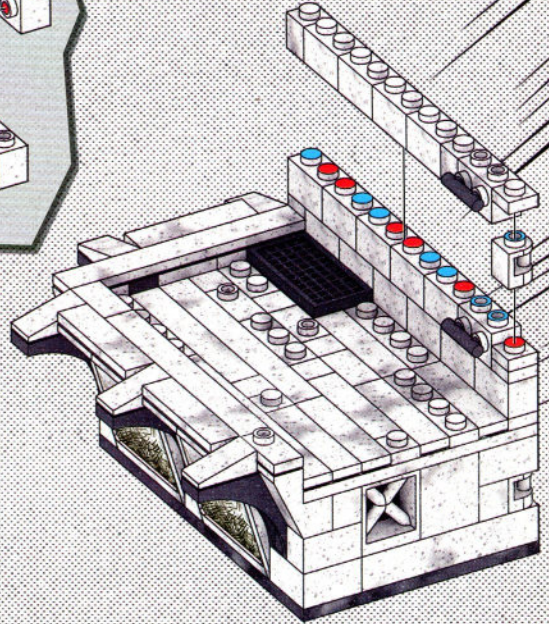
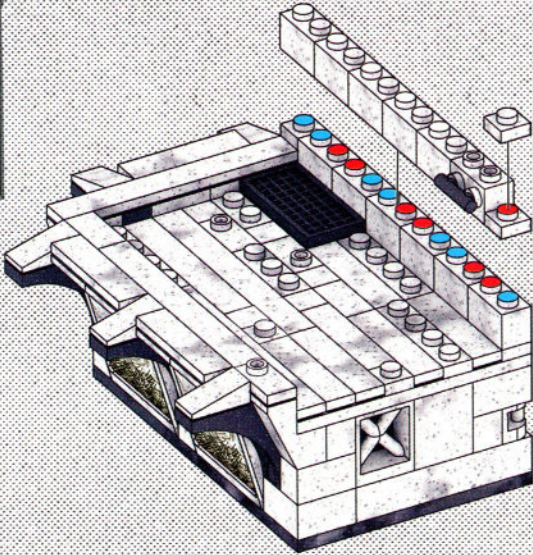
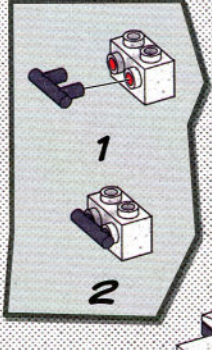
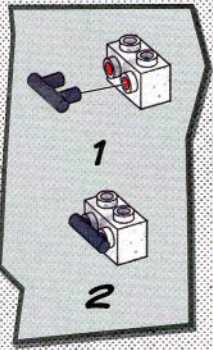

19

- 1X
- 1X
- 1X
- 5X
- 1X
- 2X

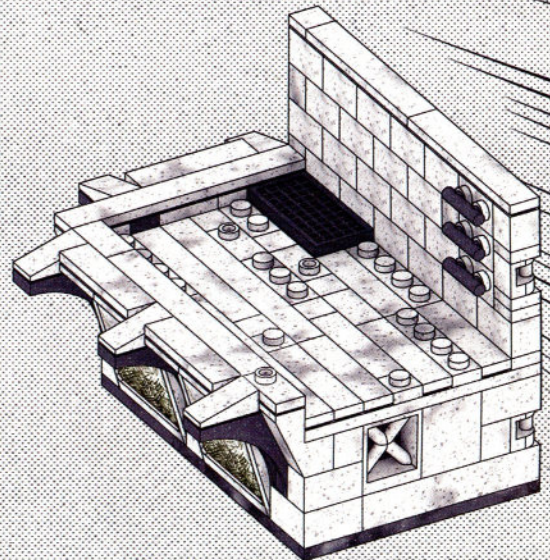
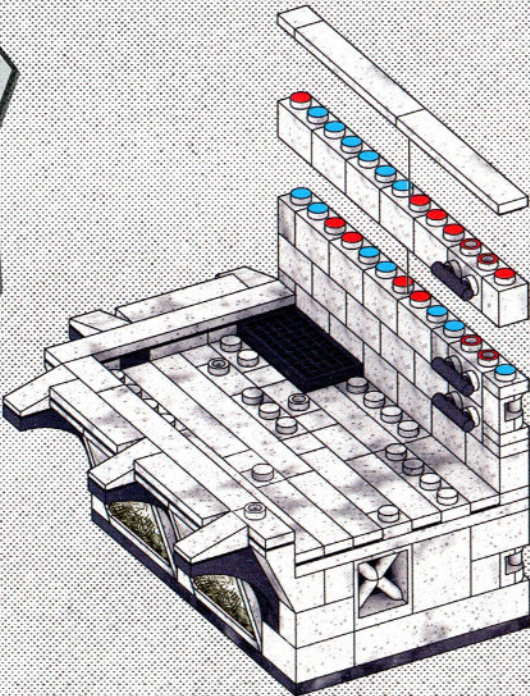
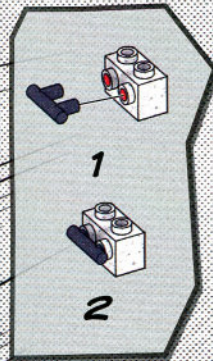

1

2

20

5X

1X

3X

2X

1X

1X

1X

2X

1X

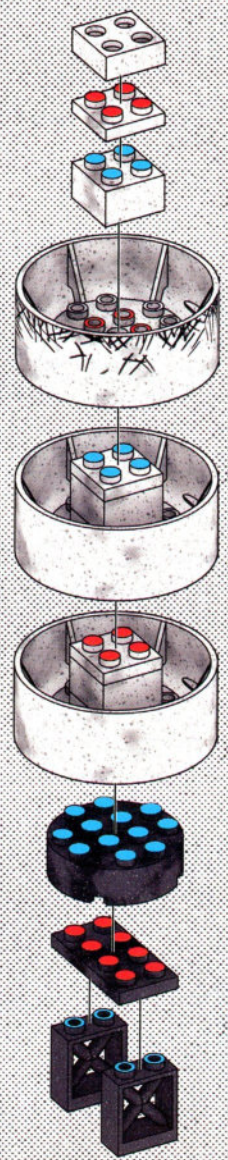
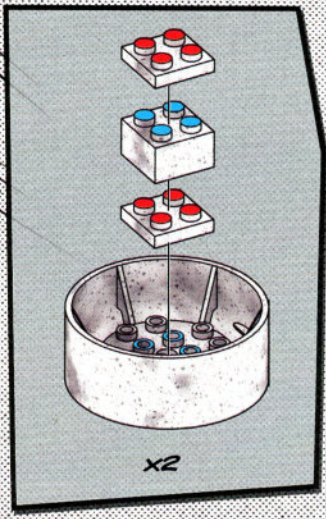

1

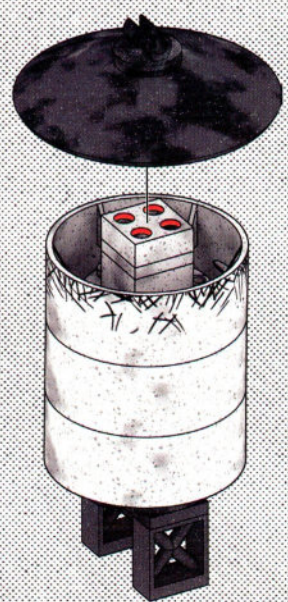

2

21

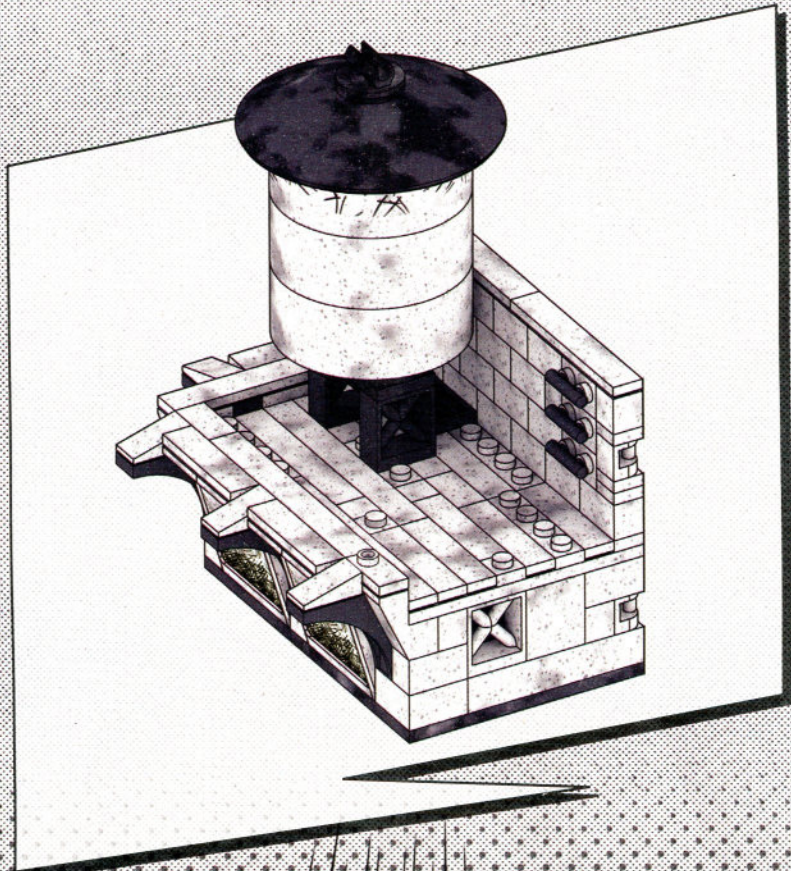
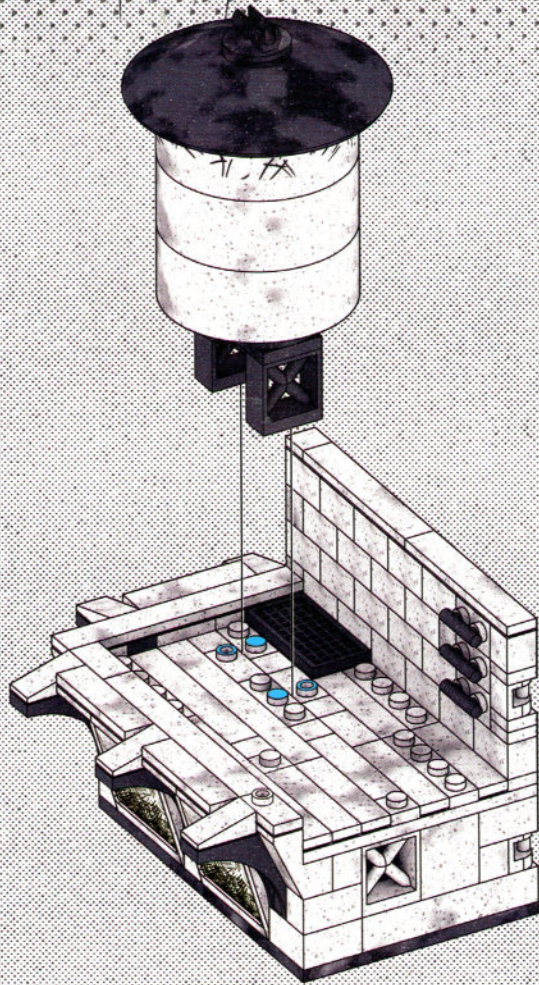

22

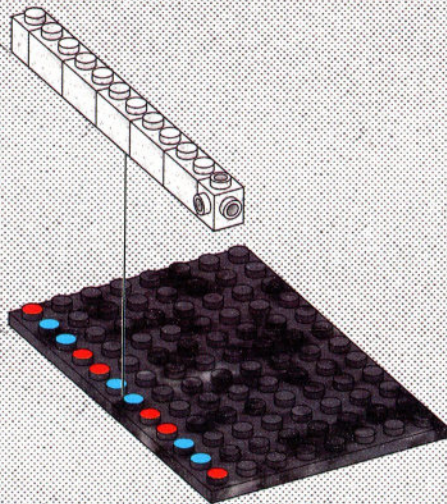
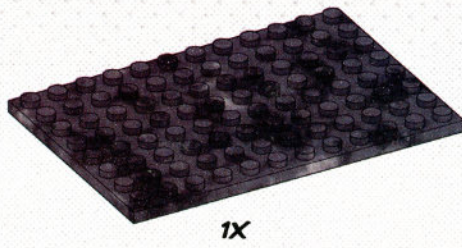
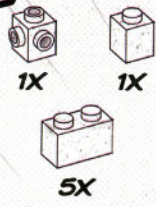

23

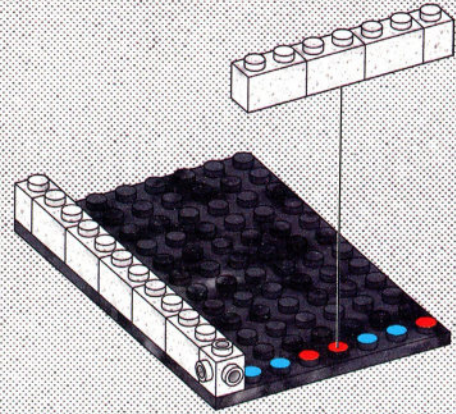
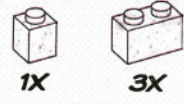

24

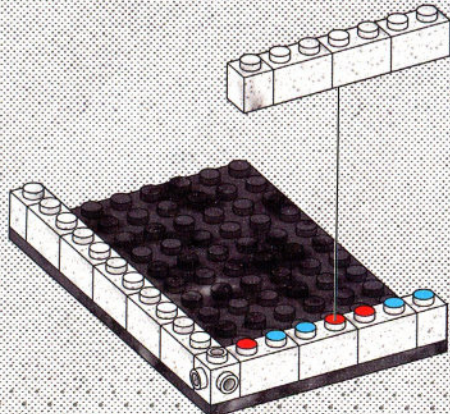
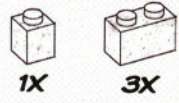

25

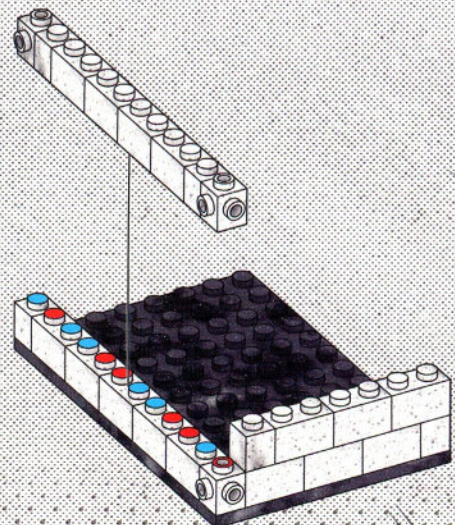
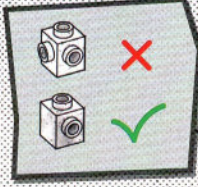
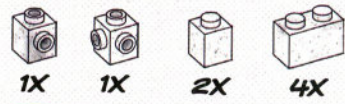

26

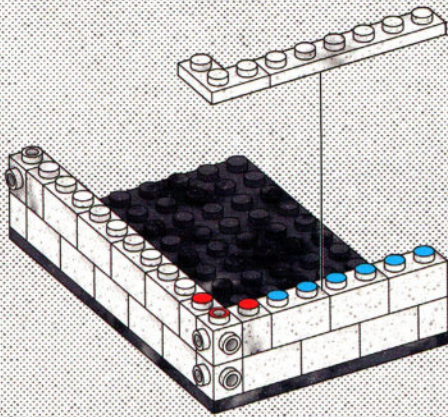
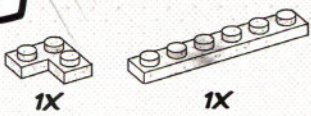

27

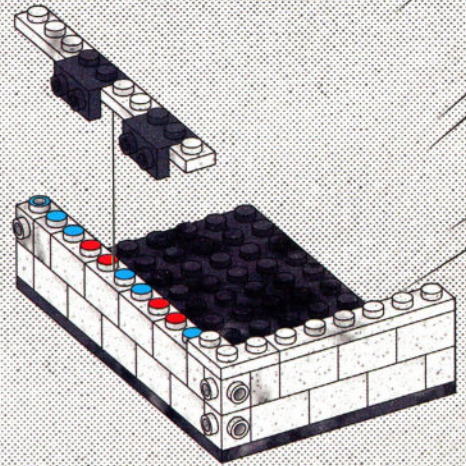
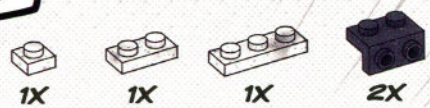

28

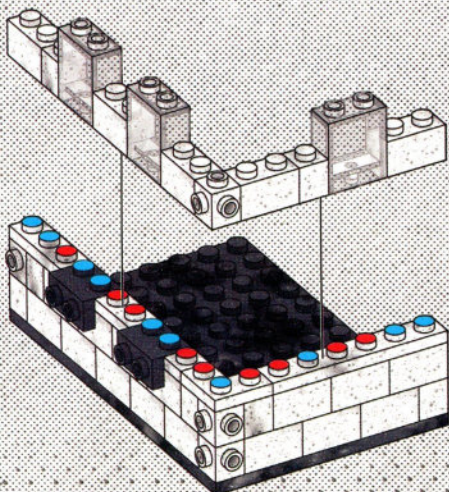
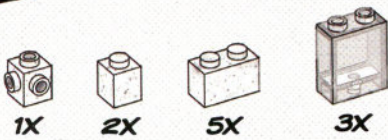

29

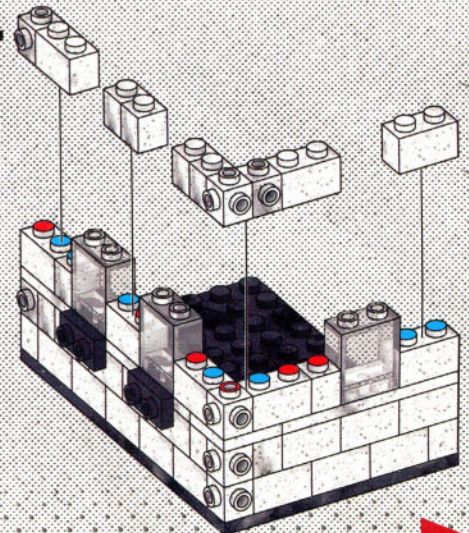
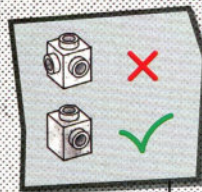
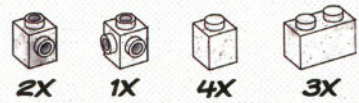

30

- 1X
- 1X
- 1X
- 5X
- 3X

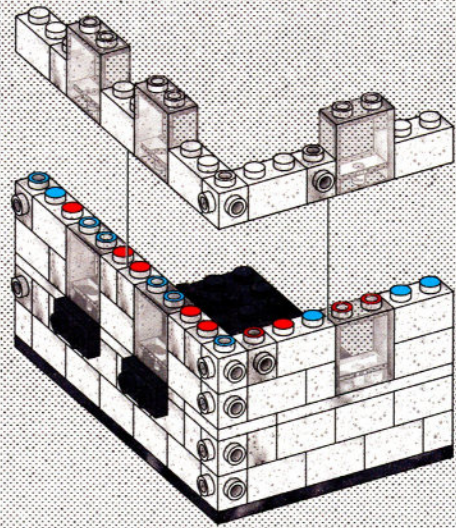

31

- 2X
- 1X
- 4X
- 3X

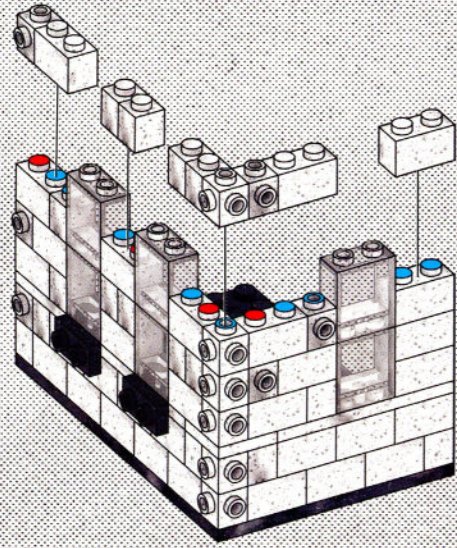
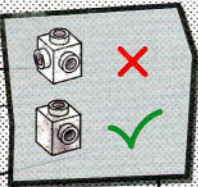

1

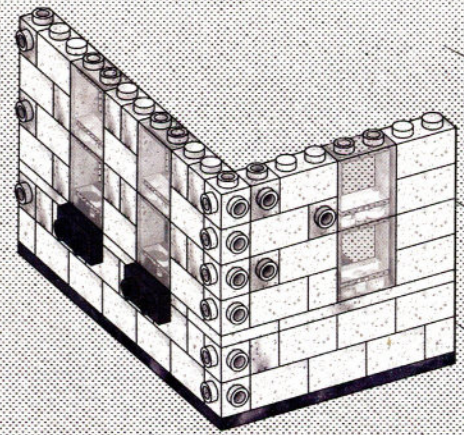

2

32

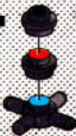
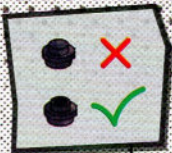
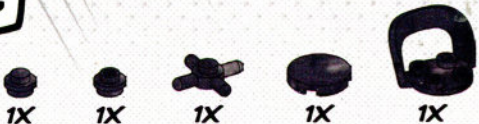

1



2



3

33



1



2

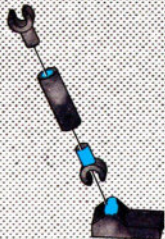

3



4



5

34

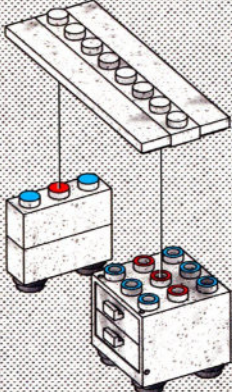
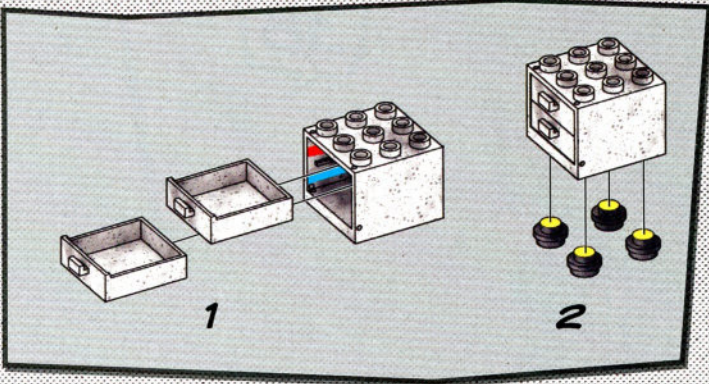
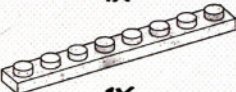
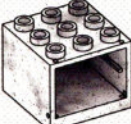

1

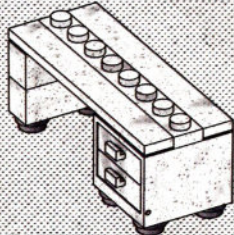

2

35

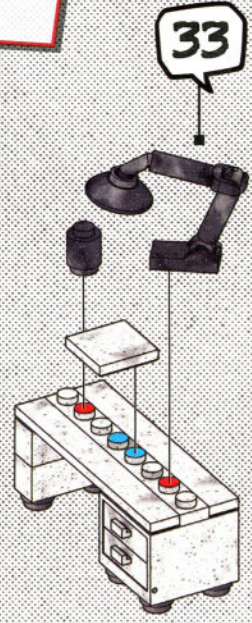
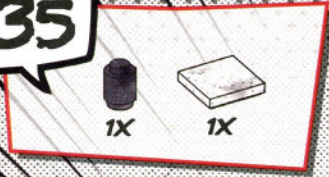

36

32

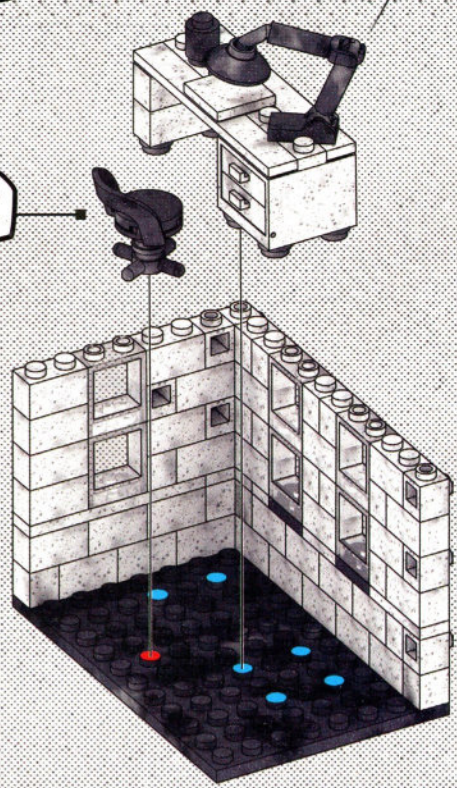

37

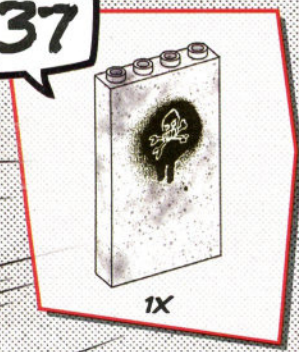

38

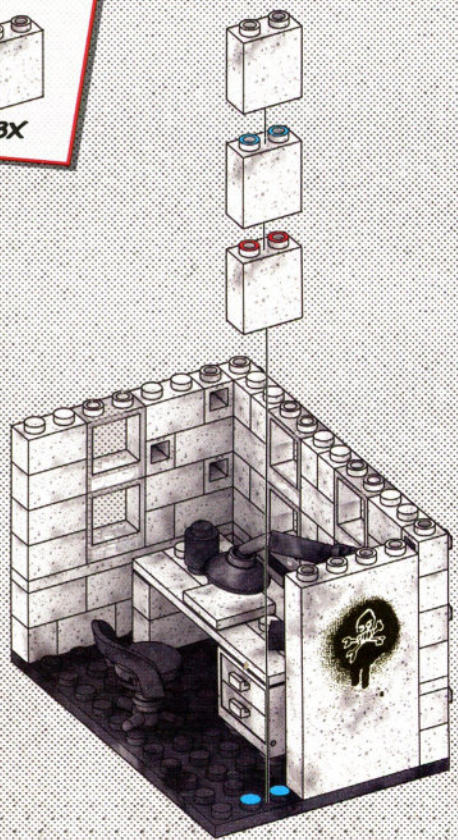
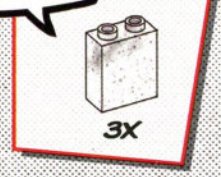

39

- 1X
- 2X

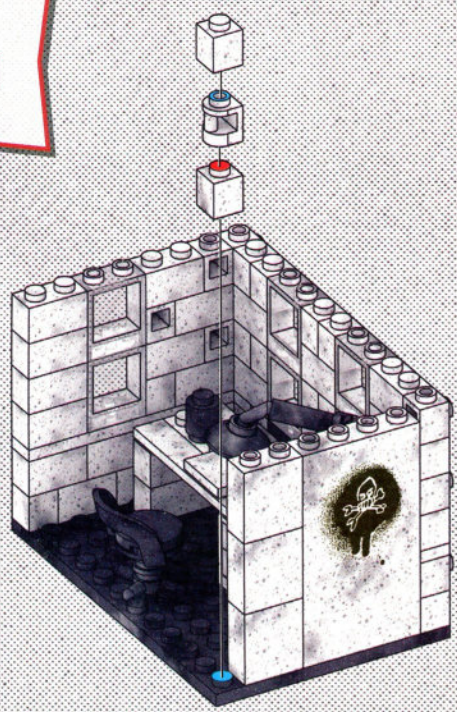

40

- 1X
- 1X
- 2X

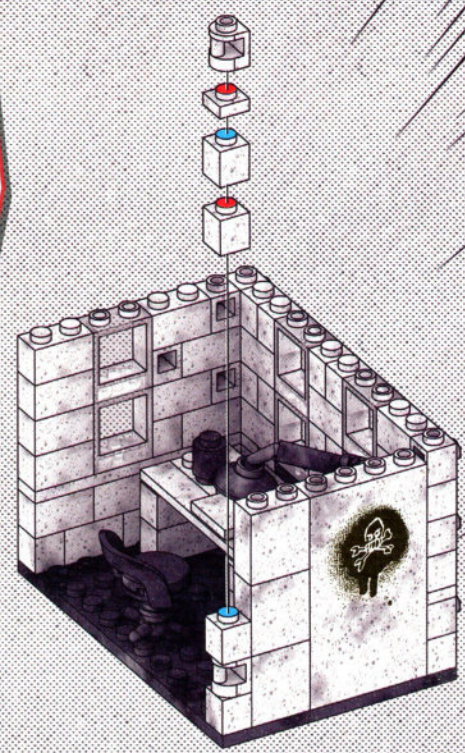

41

- 1X

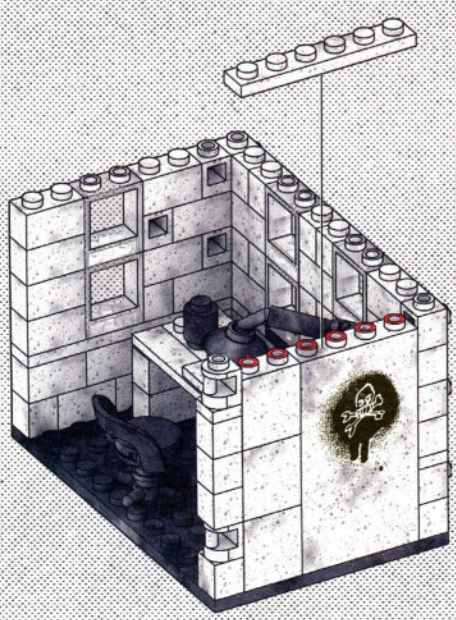

1

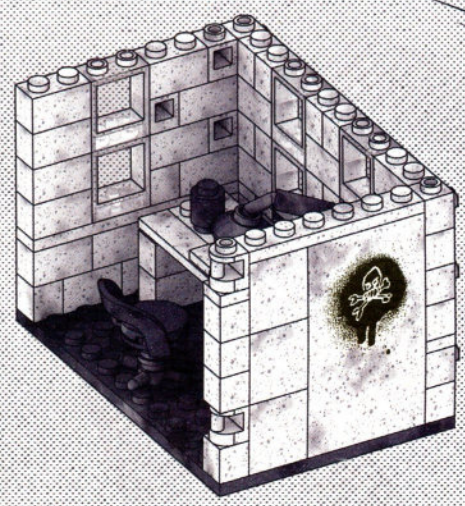

2

42

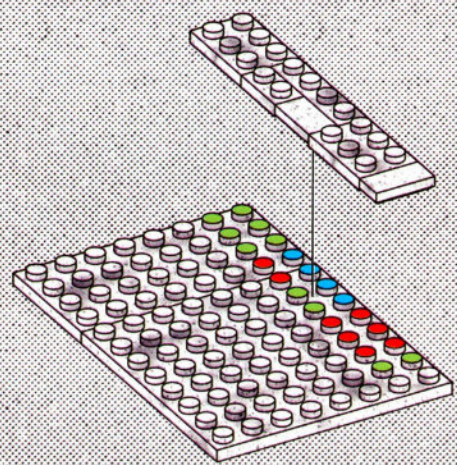
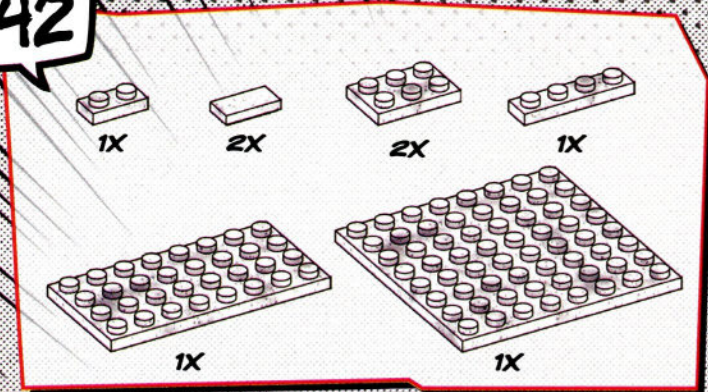

43

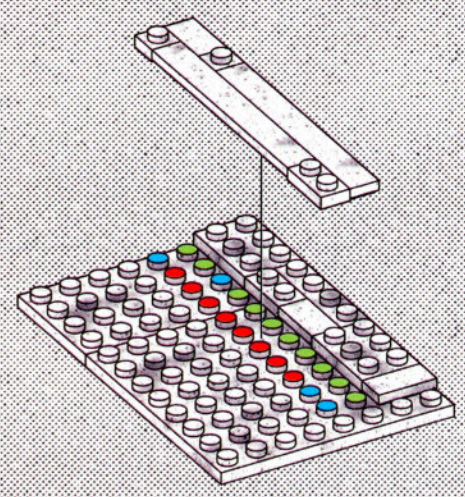
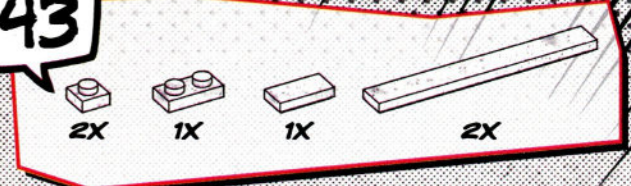

44

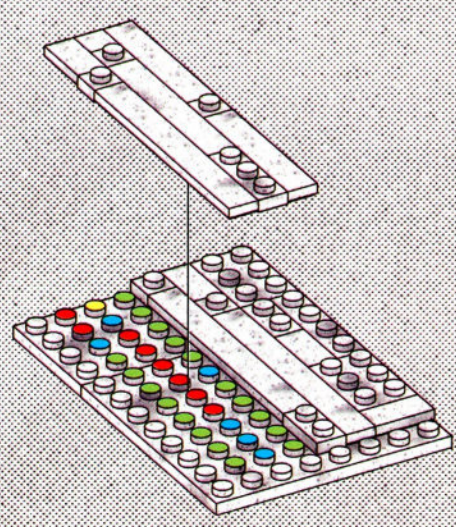
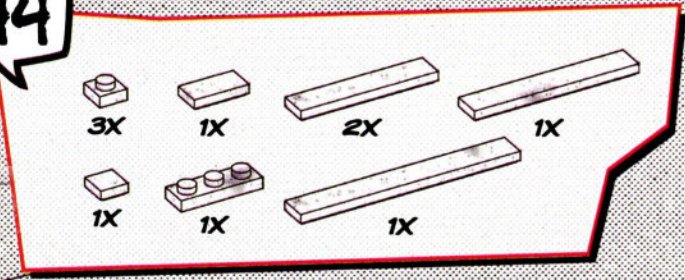

1

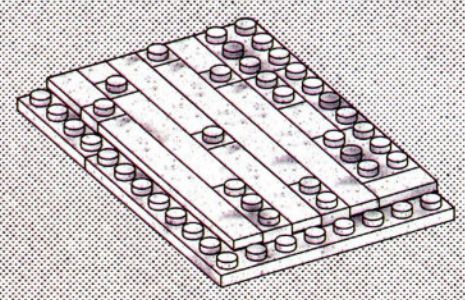

2

45

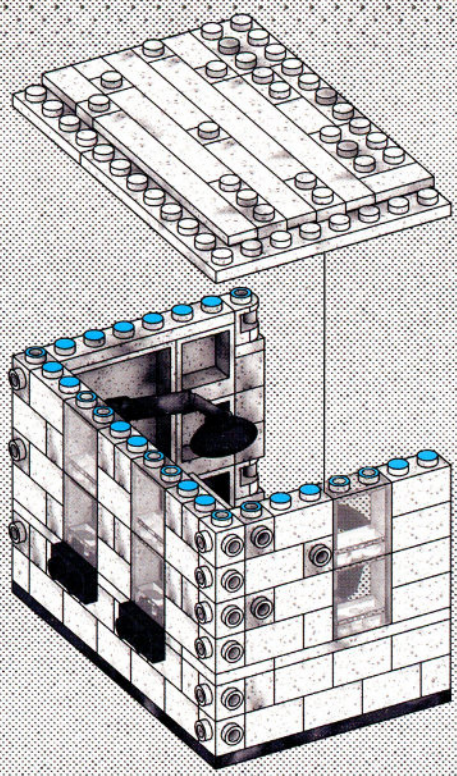

46

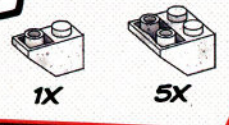

1X 5X

47

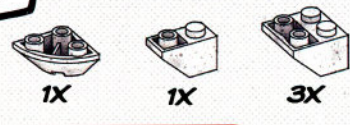

1X 1X 3X

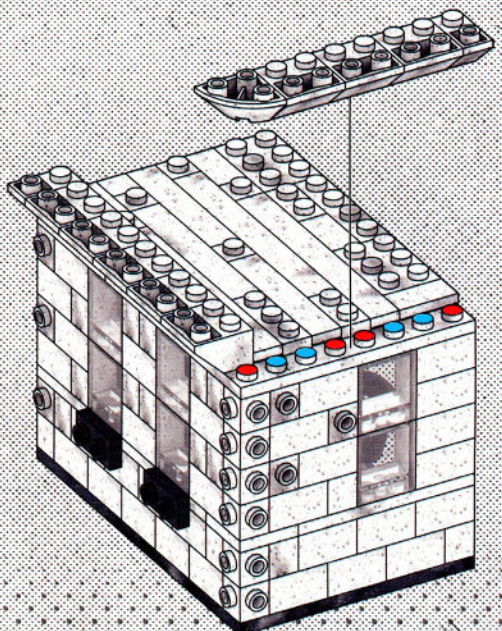
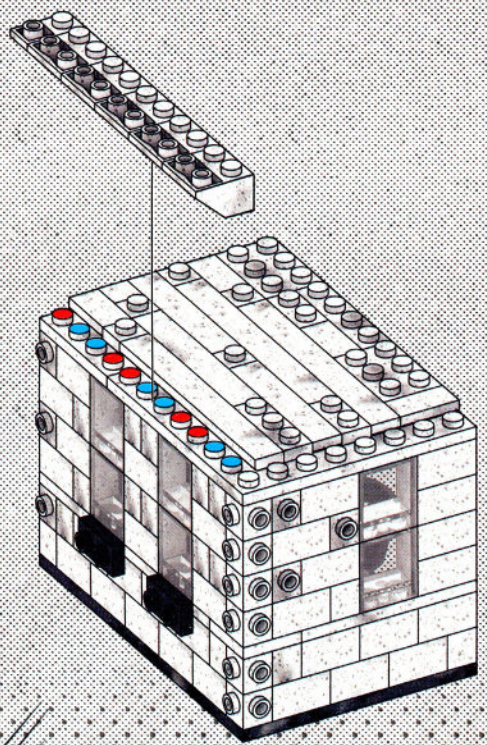

48

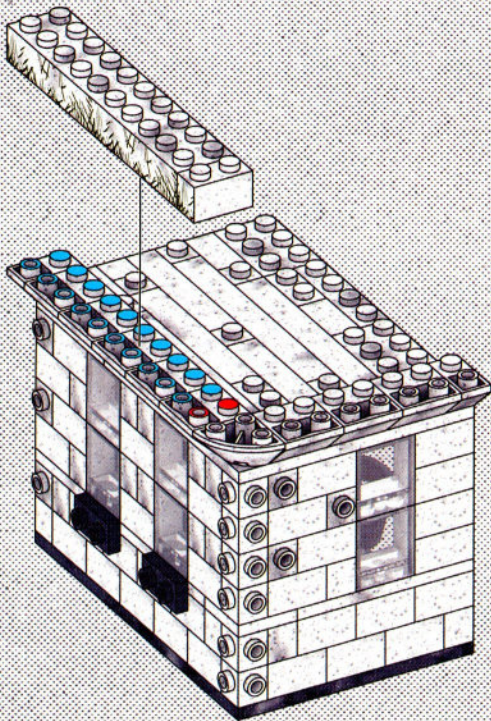
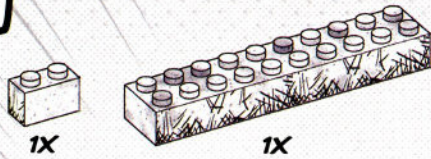

49

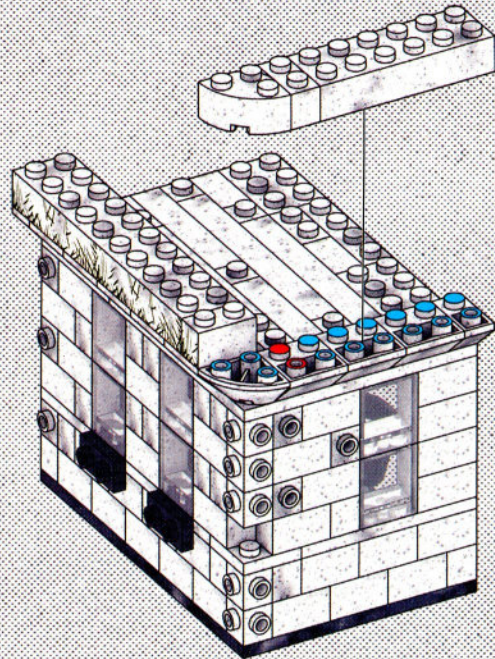
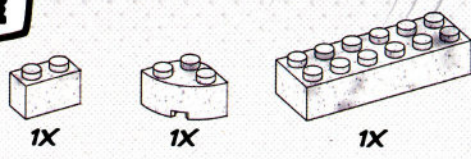

50

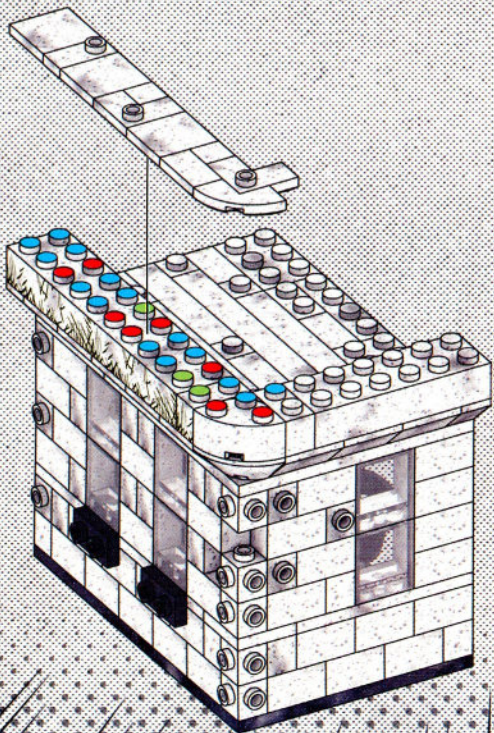
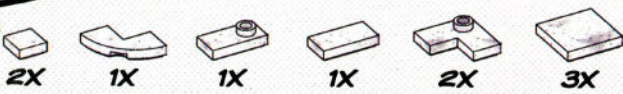

51

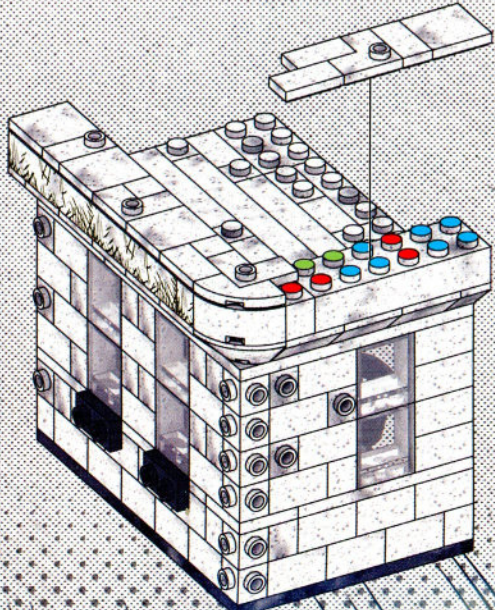
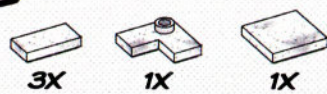

52

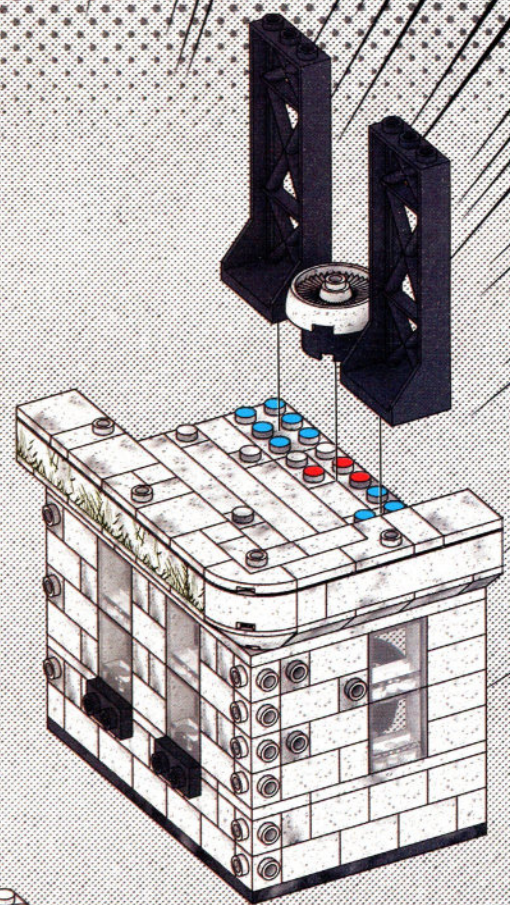
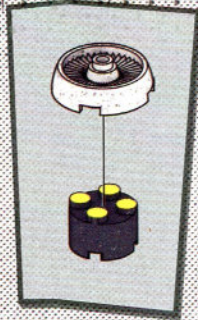
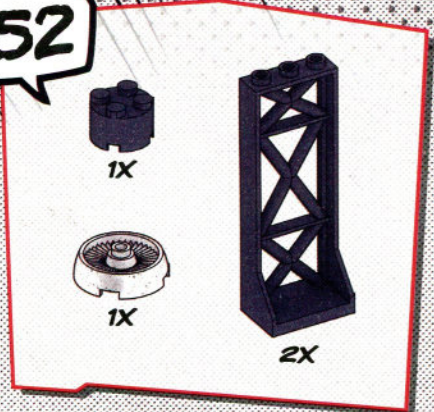

53

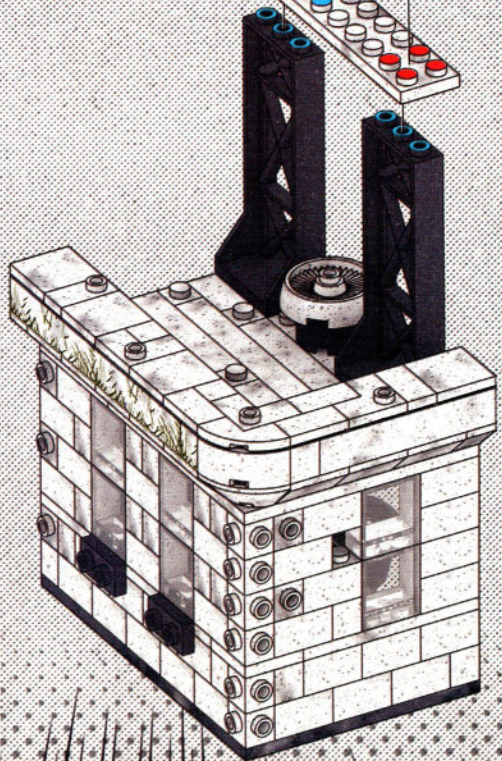
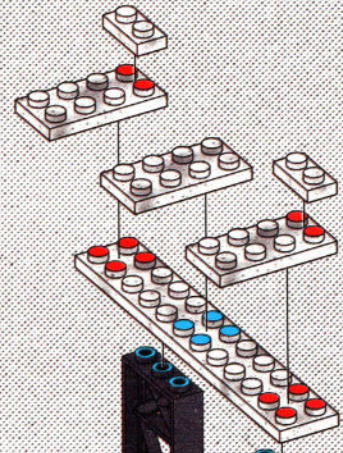
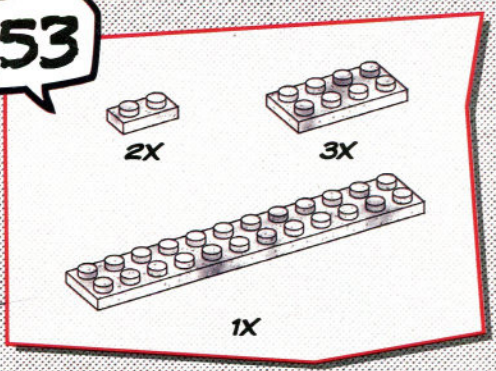

54



4X



2X

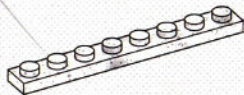

2X

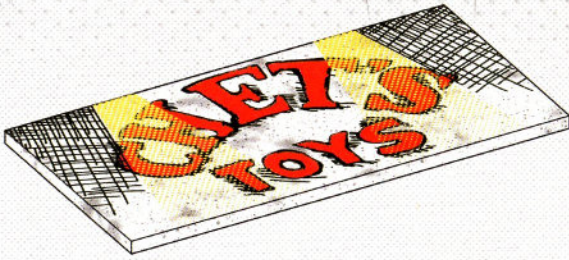

1X

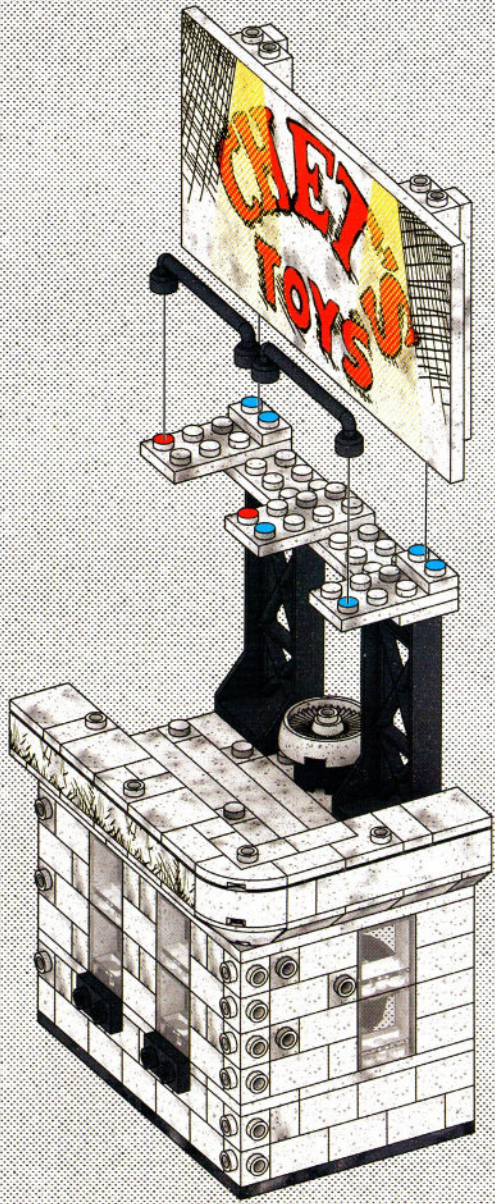
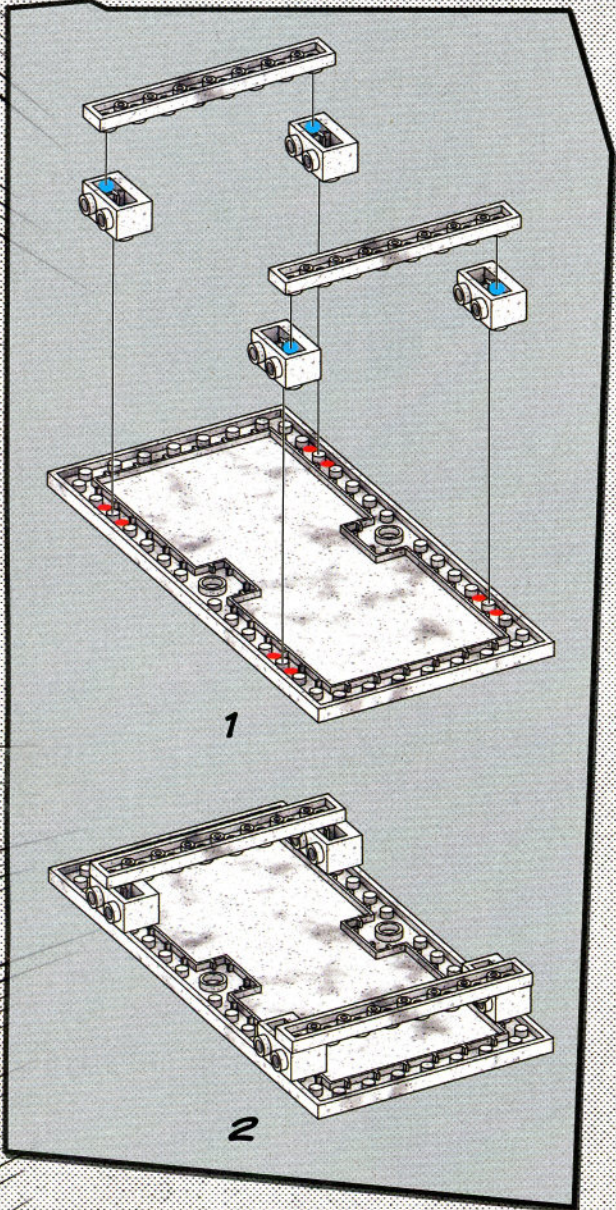

55

2X

2X

2X

2X

1X

1X

x2

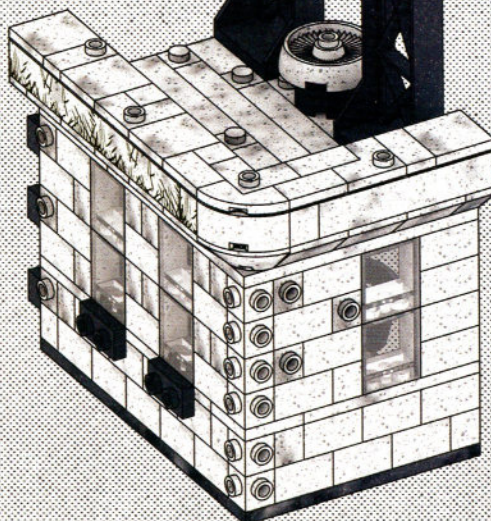
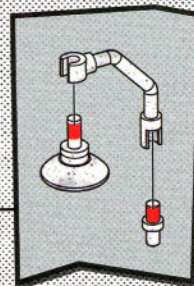
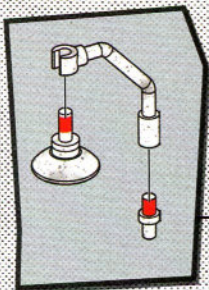

56

3X



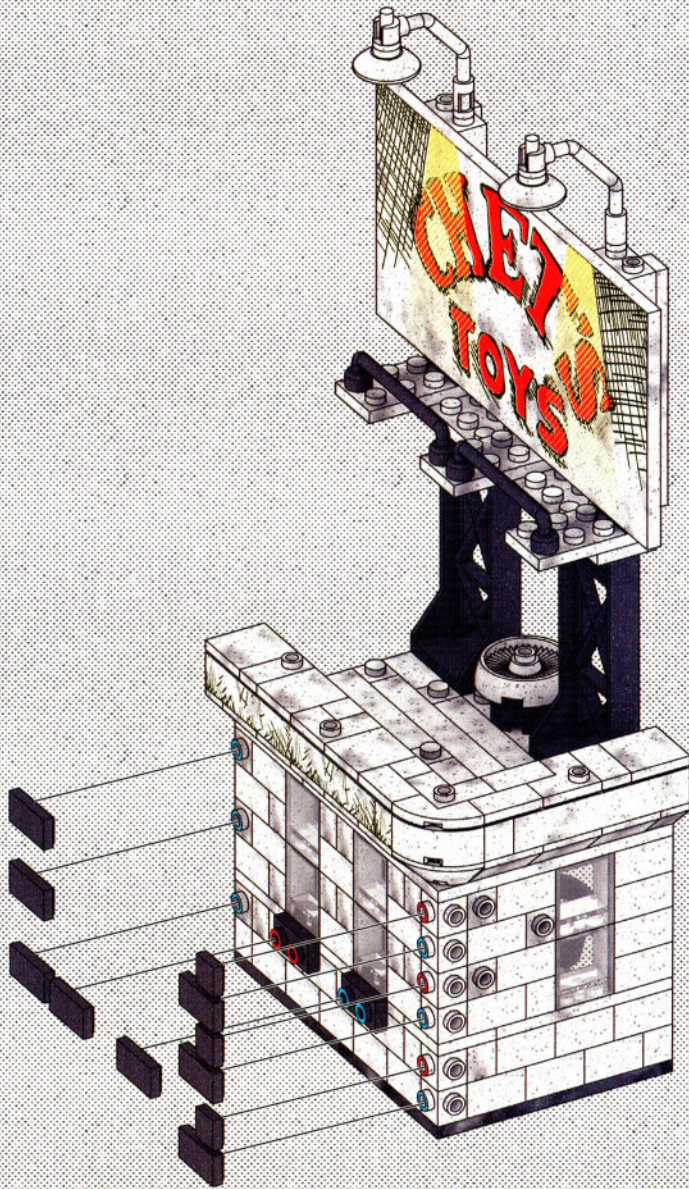

8X

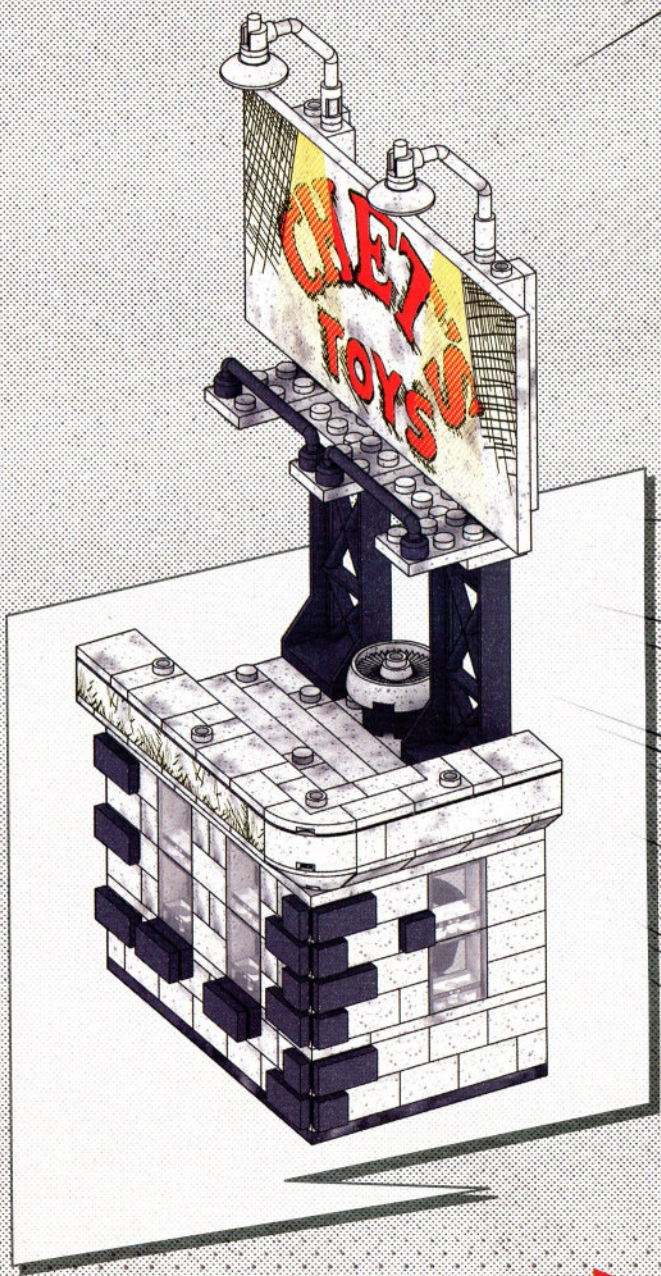
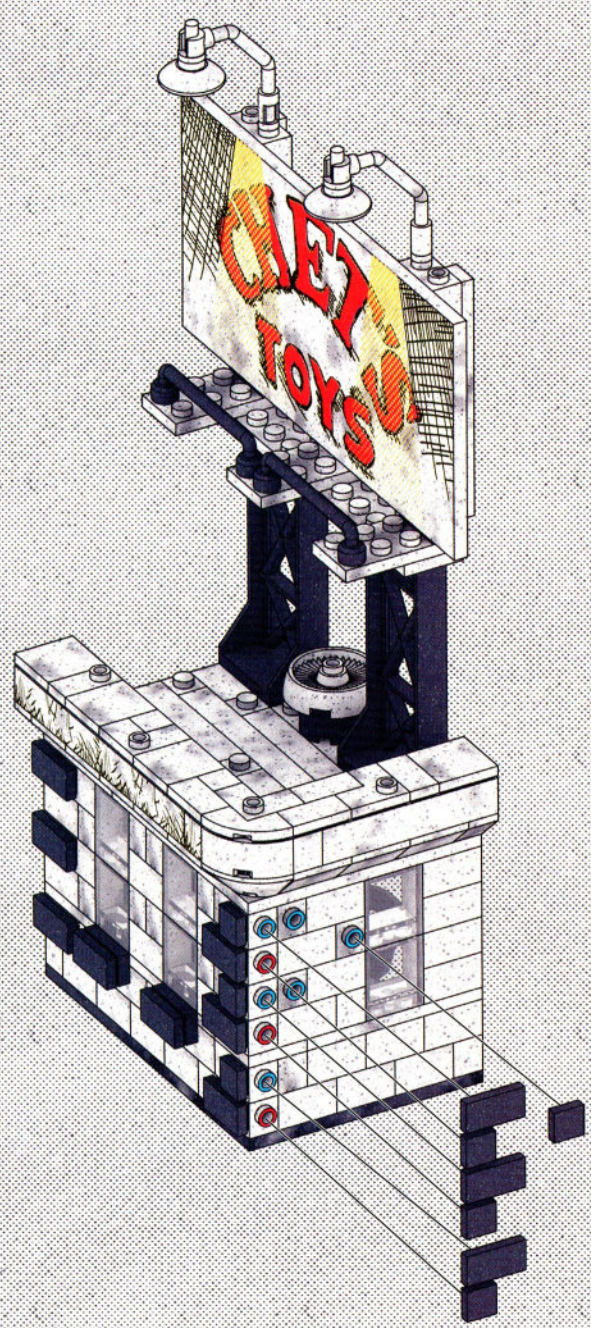

57
4X
3X



58

-  2X
-  1X
-  2X
-  1X

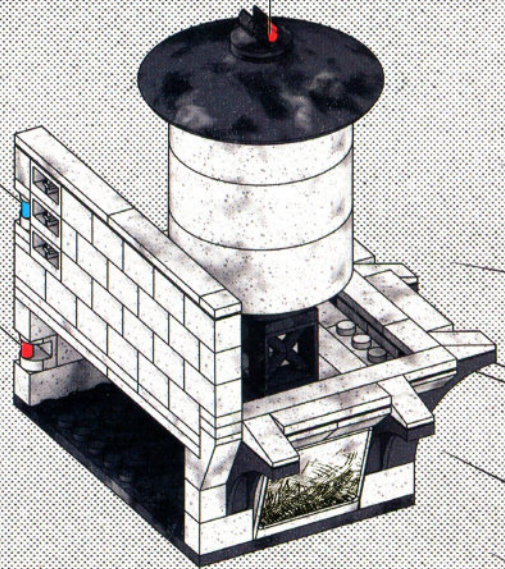
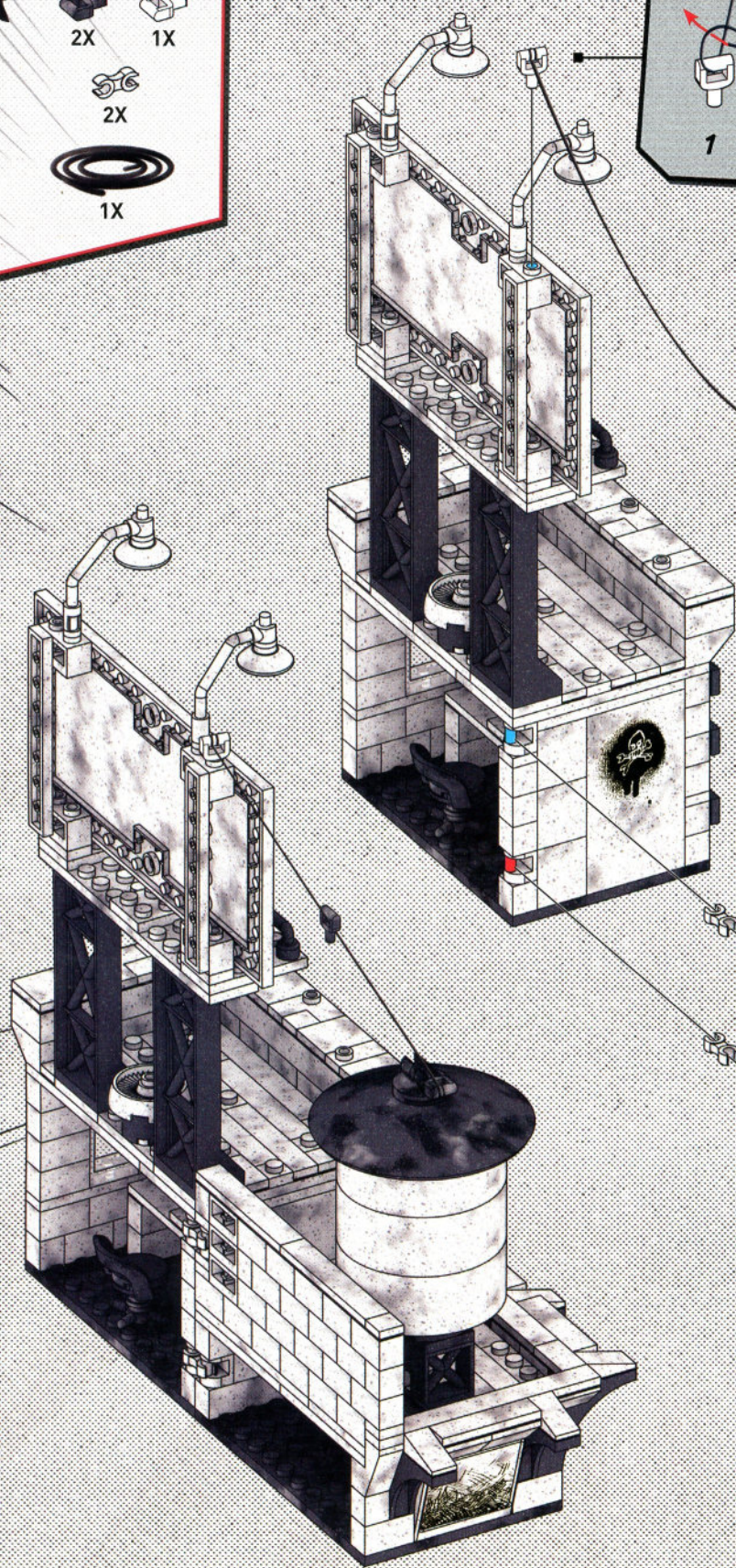
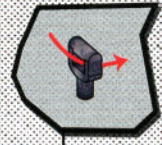
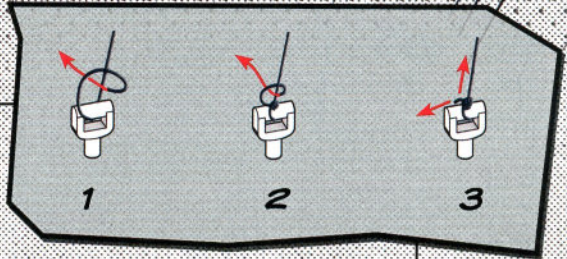

2

1



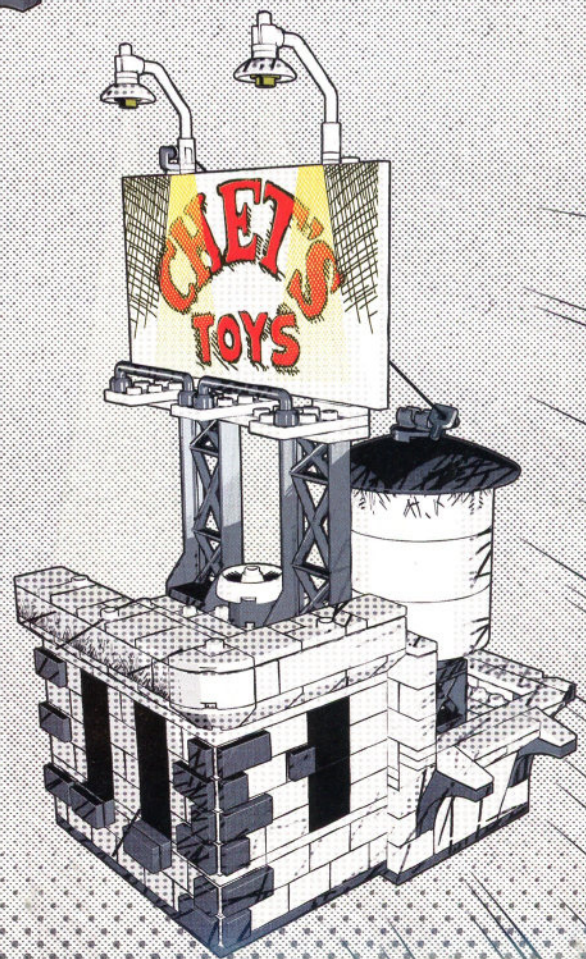
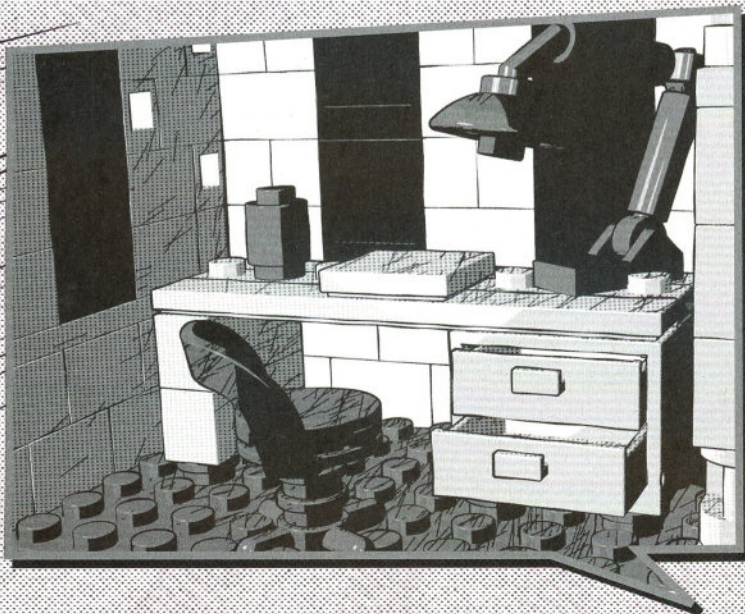
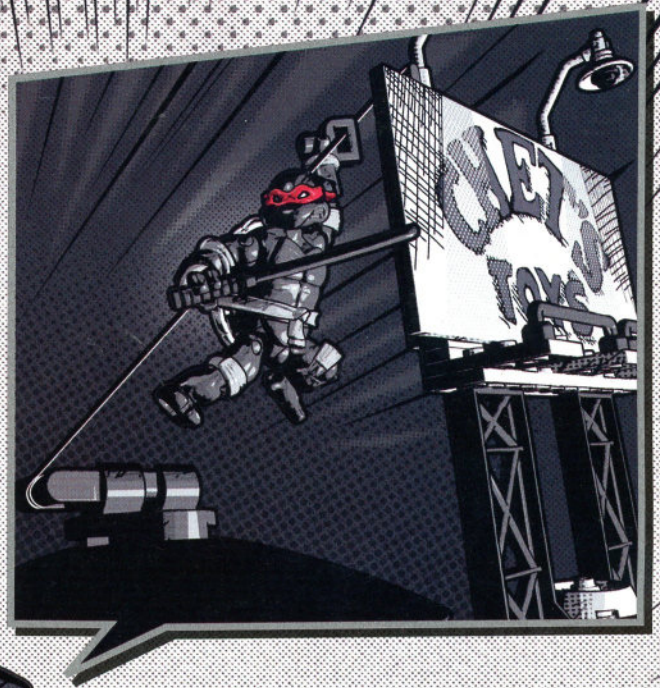
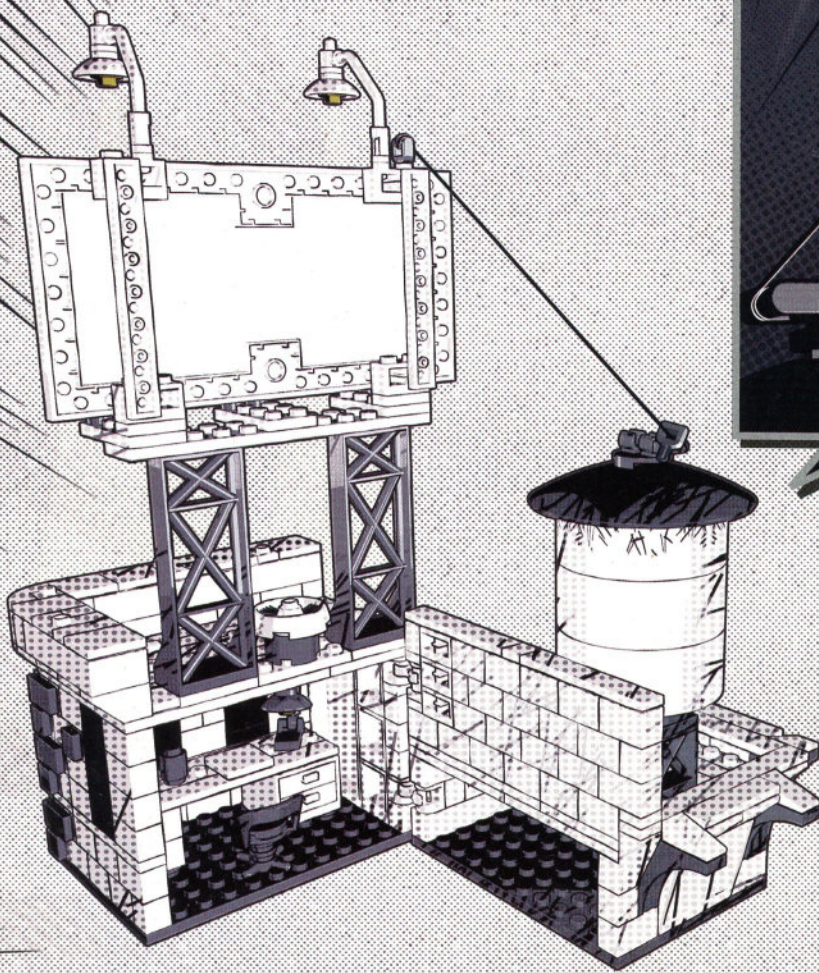

VISIT | VISITE | VISITA | VAI SU | AUF | WEJDŹ | NA GA NAAR | ПОСЕТИТЕ ВЕБСАЙТ
TMNT.MEGABLOKS.COM

TO COLLECT THE ENTIRE LINE!
 POUR DÉCOUVRIR TOUTE LA GAMME!
 PARA CONOCER TODA LA LÍNEA DE JUGUETES!
 E COLEZIONARES TODA A LINHA!
 E COLLEZIONA LA LINEA COMPLETA!
 FINDET MAN DIE GESAMTE PRODUKTLINEIE!
 ZBIERZ CAŁĄ KOLEKCJĘ!
 EN VERZAMEL ZE ALLEMAAL!
 ЧТОБЫ СОБРАТЬ ВСЮ ЛИНЕЙКУ!

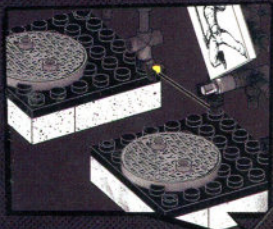

DPD84



DPD86



DPD80

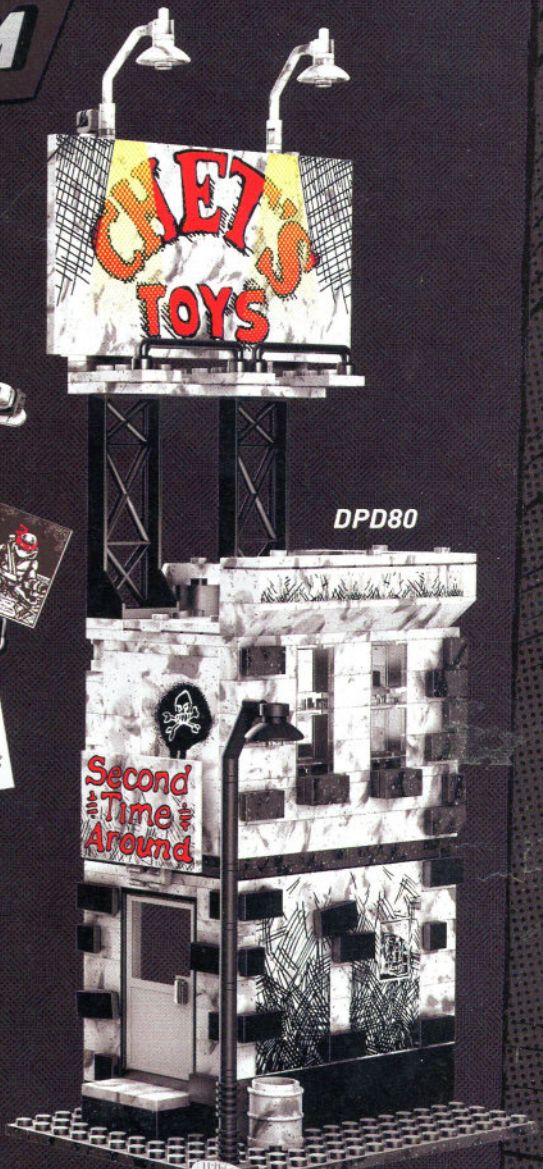

DPD79

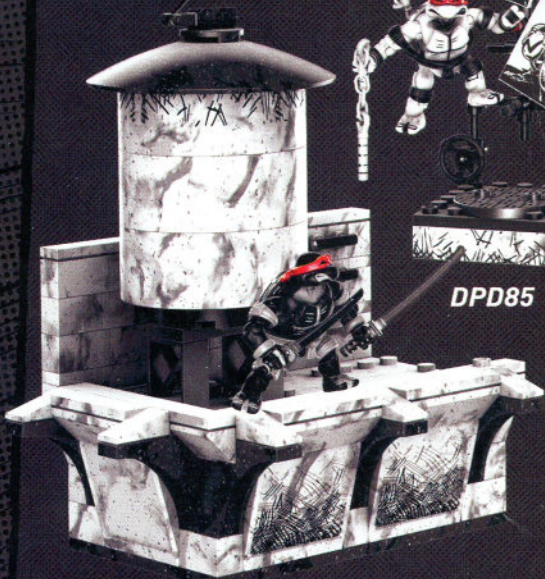

DPD80

DPD85

DPD87



Each sold separately and subject to availability. / Tous vendus séparément. Certains produits peuvent ne pas être commercialisés. / Se venden por separado y están sujetos a disponibilidad. / Vendidos em separado e sujeitos à disponibilidade. / Ognuno in vendita separatamente secondo disponibilità. / Alle Artikel separat erhältlich. Einige Artikel werden nicht in allen Ländern vertrieben. / Sprzedawane oddzielnie w zależności od dostępności. / Per stuk verkrijgbaar en niet overall leverbaar. / Каждый продукт продается отдельно, в зависимости от наличия. / Sælges separat og så længe lager haves. / Alla delar säljs separat så långt lagret räcker. / Hver leke selges separat så langt lageret rekker. / Jokainen myydään erikseen, saatavuus voi vaihdella. / Το καθένα πωλείται ξεχωριστά και ανάλογα με τη διαθεσιμότητα. / .
 نباع كل منها على حدة وتخضع لتوفرها. 每件单独出售，并且视库存情况而定。 それぞれ在庫状況に従って個別に販売されます。

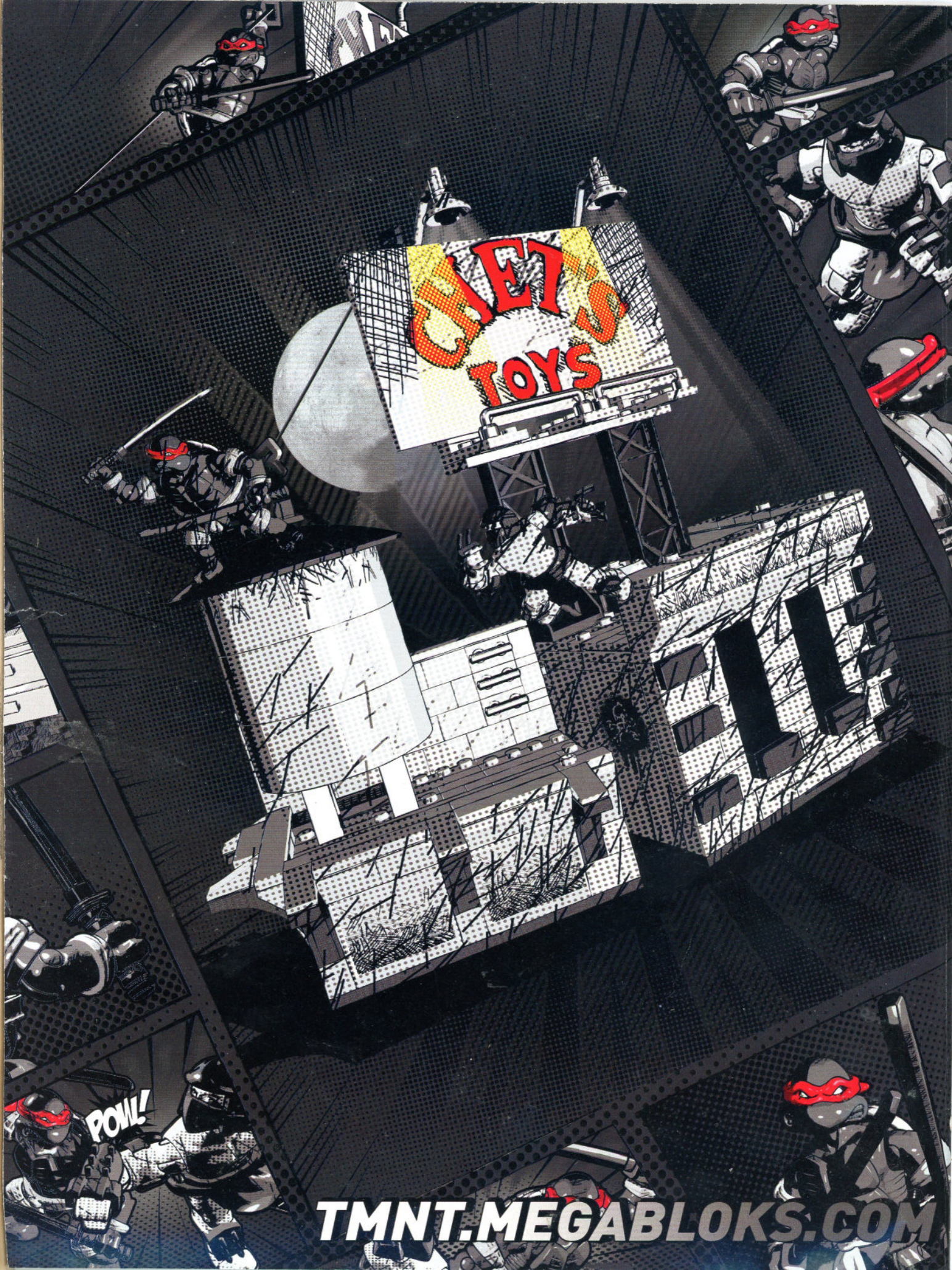

TMNT.MEGABLOKS.COM